



8 x 12 x 4 m XXL

PROFESSIONAL

DE Gebrauchsanweisung PVC-Zelt

GB Assembly instruction PVC-Tent

PL Instrukcja obsługi PVC-Namioty

NL Gebruiksaanwijzing PVC-Tent







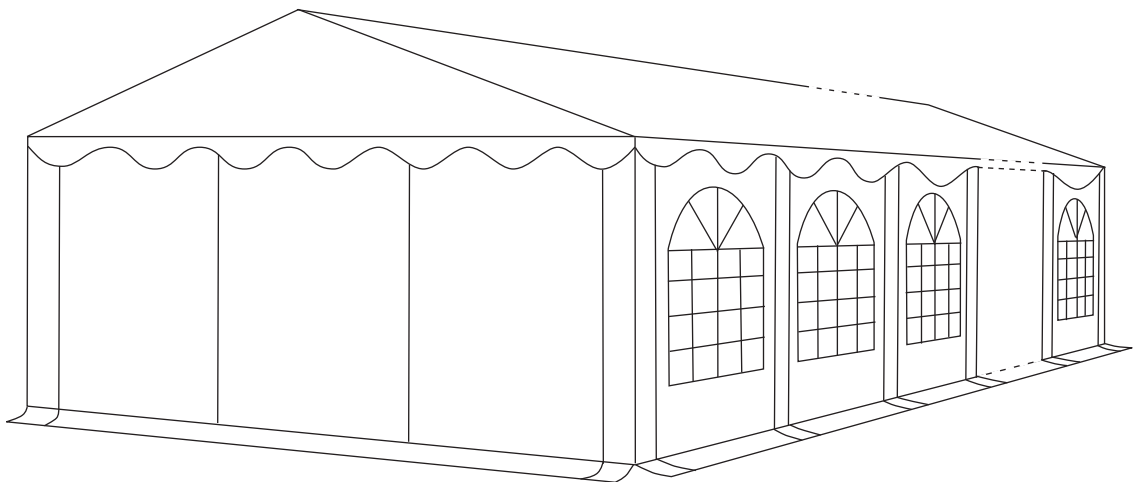





FR Mode d'emploi Tente PVC

CZ Instrukce PVC Stan



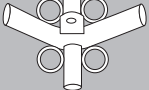



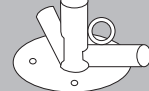
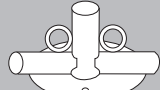
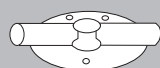





ES Manual de instrucciones Carpa de PVC

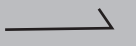
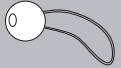

Inhalt

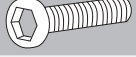
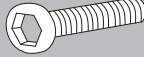
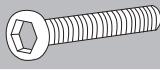
Artikel Nr.	Beschreibung	ID Nummer		8x12m
30672	Stange 1980 mm 50-50 mit Löchern	1		14
30522	Stange 1920 mm 38-38 mit Löchern	2		50
30523	Stange 1960 mm 50-50 mit Löchern	3		28
30524	Stange 750 mm Dachstrebe 8er vertikal	4		7
30525	Stange 1987 mm Dachstrebe 8er horizontal	5		14
30673	Stange 1980 mm 50-50 mit 2 Löchern	6		14
30526	3er Eckverbinder 110° 54-42 mit Ringen	7		4
30527	3er Eckverbinder 140° 54-42 mit Ringen	8		2
30528	4er Eckverbinder 140° 54-42 mit Ringen	9		5
30529	4er Eckverbinder 110° 54-42 mit Ringen	10		10
30421	T-Stück 54-42	11		4
30420	Kreuzstück 54-42h	12		10
30530	3fach Verbinder - Fuß für die Ecken 54-42 mit Ring, rechts	13		2
30531	3fach Verbinder - Fuß für die Ecken 54-42 mit Ring, links	14		2
30532	3fach Verbinder - Fuß für die Seitenwände 54-42 mit Ringen	15		10
30424	2fach Verbinder - Fuß 42-42	16		6 2

Inhalt

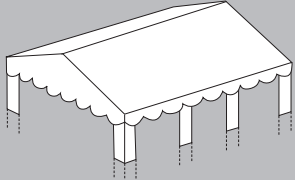
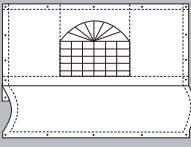
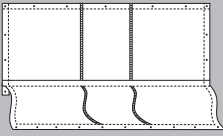
Artikel Nr.	Beschreibung	ID Nummer		8x12m
30622	Spanner für die Seiten	17		8
30534	Spanner für das Dach	18		12
30044	Schraubhaken	19		4
30046	Erdnagel 6x180 mm	20		20
30047	Erdnagel 4x160 mm	21		36
30430 14 cm	Gummischlaufe	22		296
30429 5 cm	Gummischlaufe	23		20
30050	Spannleine 5 m	24		4
30051	Dachhaken	25		14
30382	Imbusschlüssel	26		1
30384	Schraube 30 mm	27		28
30404	Schraube 45 mm	28		100
30405	Schraube 65 mm	29		100
30052	Flügelmutter	30		28
30535	Mutter	31		200
30380	Maulschlüssel	32		2
	Dach	33		1
	Seitenwand	34		12
	Endwand	35		2

Gebrauchsanweisung

1

Suchen Sie einen ebenen Untergrund für das Zelt. Packen Sie die Kartons aus und sehen Sie nach, ob auch alle hier aufgelisteten Teile vorhanden sind.

Setzen Sie den Rahmen für das Dach zusammen indem Sie die Teile 7 bis 12 an die Stangen (Teile 2 und 3) montieren und zur Fixierung mit den Schrauben fest anziehen.

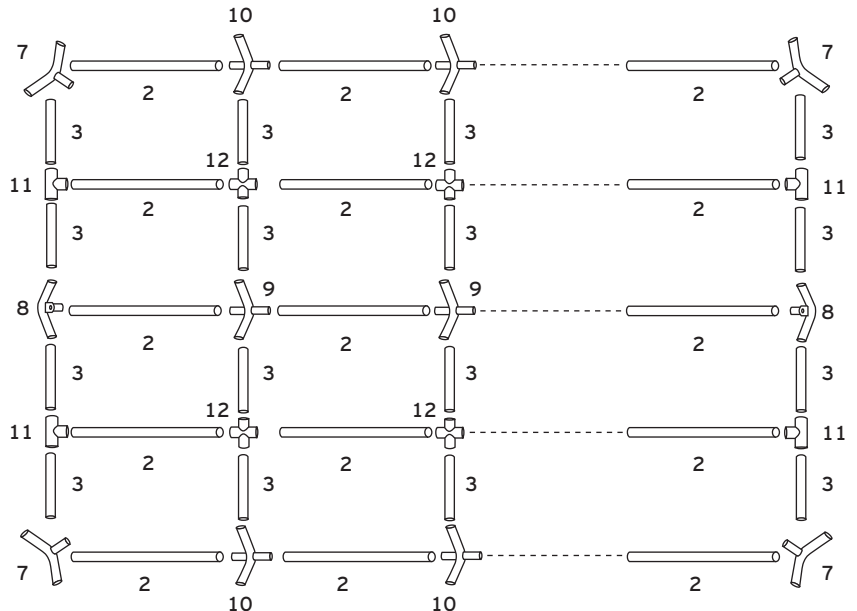

2

Das Dach mithilfe der Spannvorrichtung (18) stabilisieren. Die Befestigung erfolgt schräg über jeweils zwei Abschnitte entsprechend der Abbildung unten.

Befestigen Sie die Verstärkungsstreben (Teile 4 u. 5) mit Schrauben (27) und Flügelmuttern (30).

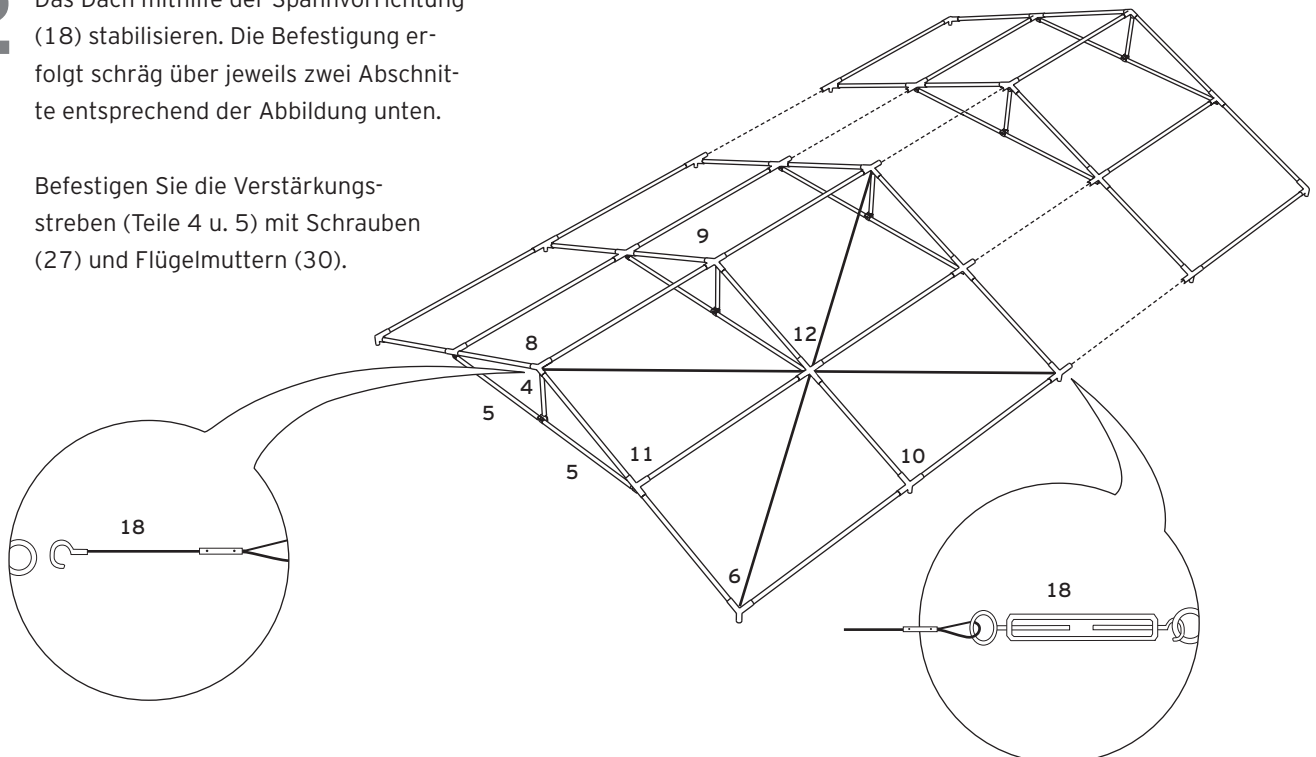

3

Heben Sie eine Seite des Zeltgerüsts an und setzen Sie die Beine (6) ein. Setzen Sie das Dach (33) auf den Rahmen und befestigen Sie es mit den Gummischlaufen (23). Achten Sie darauf, nicht zu viel Spannung auf die Gummischlaufen zu geben, um das Anbringen der anderen Seite nicht zu erschweren.

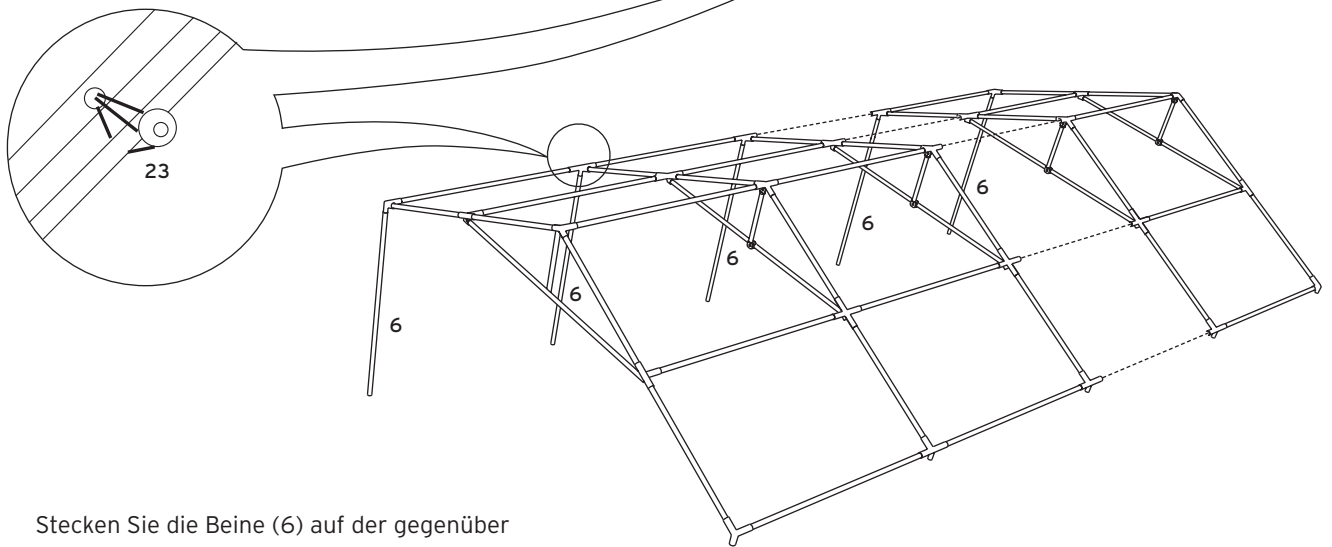
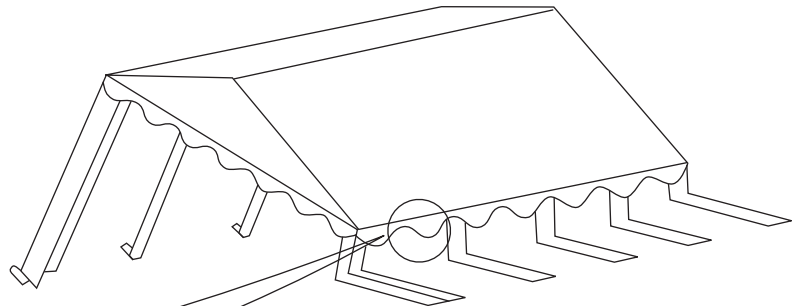

4

Stecken Sie die Beine (6) auf der gegenüberliegenden Seite ein. Setzen Sie jetzt erst auf der einen Seite die Stangen (1) an die Stangen (6) und montieren Sie an den unteren Enden die FüÙe (13/14/15). Setzen Sie dann auf der anderen Seite die Stangen (1) an die Stangen (6)

Die Dachschiß werden mit Haken (25) an den Stangen (1) befestigt. Mit der Spannvorrichtung (17) verstärken Sie den Seitenrahmen. Anschließend vervollständigen Sie den Bodenrahmen mit den entsprechenden Stangen (2) / Verbindern (13/14/15/16).

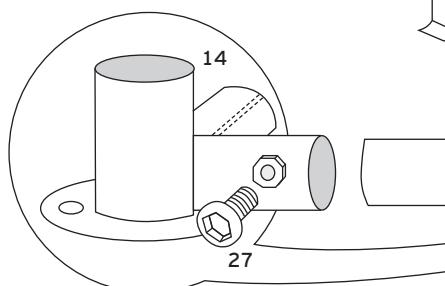
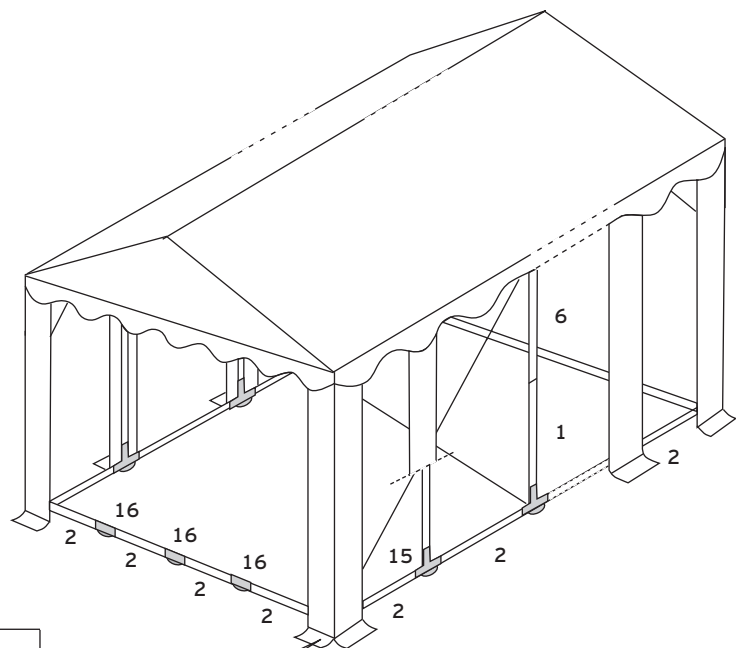

- 5** Breiten Sie die Seitenwände (34) und Endwände (35) aus und befestigen Sie die Seitenwände mit den Gummischlaufen (22) am Gerüst und die Endwände mit den kurzen Gummischlaufen (23) direkt am Dach. Mit den kurzen Erdnägeln (21) befestigen Sie die Endwände am Boden. Die Spannleine läuft von jeder Ecke des Zeltes und wird mit dem Schraubhaken (19) am Boden verspannt.

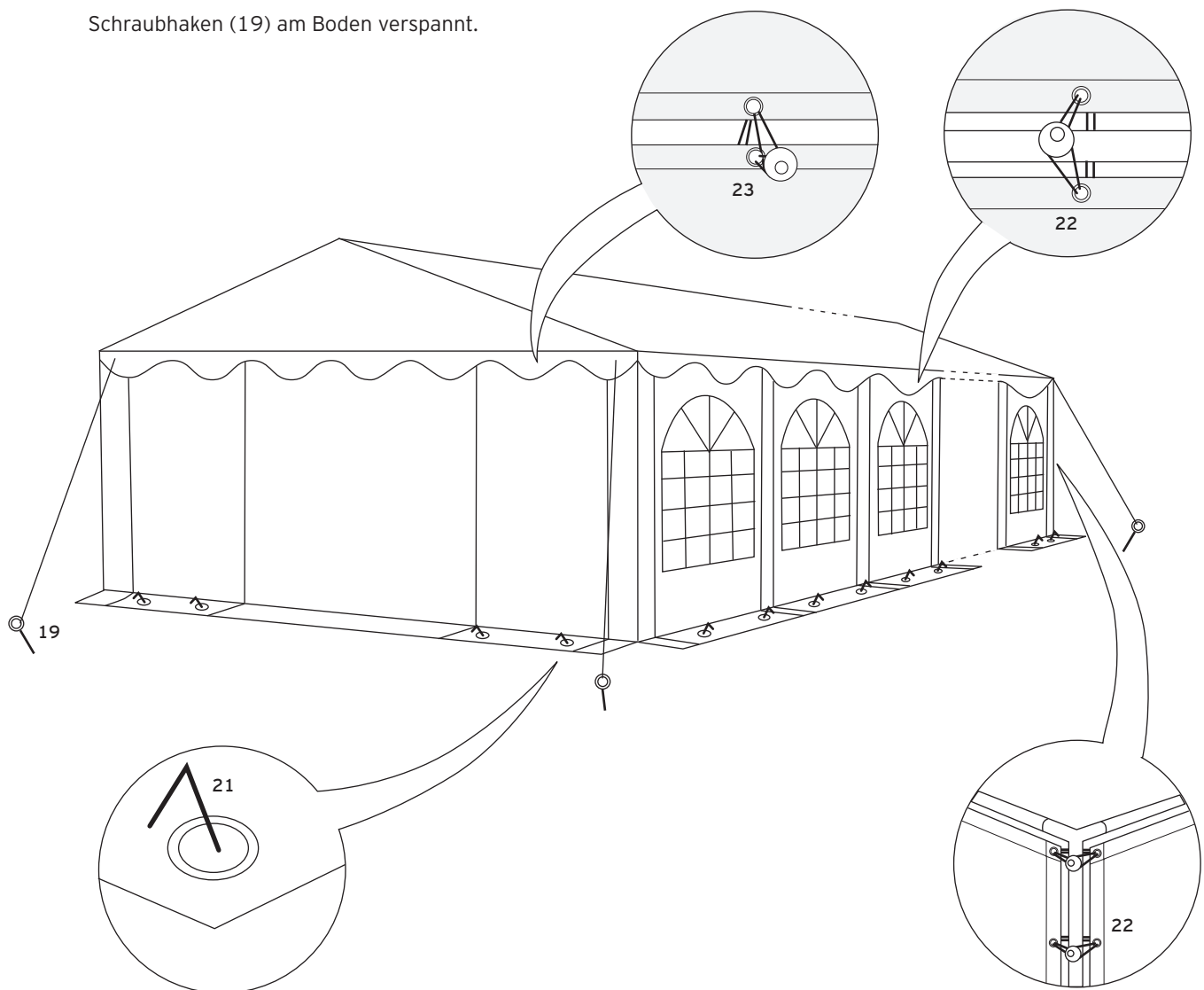

Reinigung und Wartung











Dach und Seitenteile lassen sich mit Seifenlauge abwaschen. Schimmel und Stockflecken entfernen Sie mit einer milden Chlorklösung. Befolgen Sie die Anweisungen des Herstellers und testen Sie die Chlorklösung an einer nicht sichtbaren Stelle, um sicherzugehen, dass keine Verfärbungen auftreten.

Achtung! Das Partyzelt darf nicht im nassen Zustand zusammengelegt und verpackt werden. Lassen Sie es vorher vollständig trocknen.





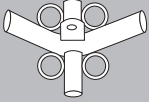
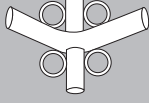

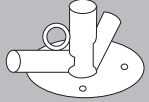
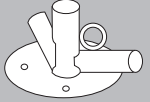
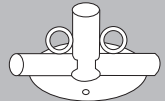
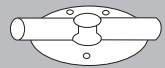



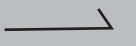

Warnung

1. Bitte achten Sie darauf, das Zelt vorsichtig zu behandeln, um Defekte zu vermeiden.
2. Das Gestänge nicht zu kräftig behandeln, da dies ansonsten Beschädigt werden könnte.
3. Zelte sind als temporäre Unterkunft gedacht und sollten bei widrigen Witterungsverhältnissen abgebaut werden.
4. Bitte wählen Sie immer einen geeigneten Abstand zu Schläuchen, Gas- oder Elektroleitungen, um diese nicht zu beschädigen.
5. Beim Einsatz geeigneter Heizgeräte (z. B. Auskunft im Fachhandel) ist ein Abstand von mindestens 1,2 m zu jeglichem Planenmaterial zu beachten. Offenes Feuer sowie Heizgeräte mit offenen Flammen wie Heizpilze, Terrassenstrahler, Gasheizer etc. sollten auf keinen Fall verwendet werden.
6. Der Aufbauer ist verantwortlich für die angemessene Verankerung und damit für die Sicherheit des Zelt.

Contents

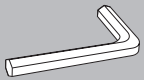
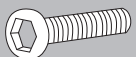
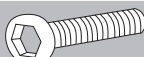
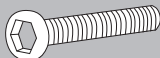
Part no.	Description	ID no.		8x12m
30672	pipe 1980 mm 50-50 with holes	1		14
30522	pipe 1920 mm 38-38 with holes	2		50
30523	pipe 1960 mm 50-50 with holes	3		28
30524	pipe 750 mm roofreinforcement 8-series vertical	4		7
30525	pipe 1987 mm roofreinforcement 8-series horizontal	5		14
30673	pipe 1980 mm 50-50 with 2 holes	6		14
30526	connector three way 110° 54-42 with rings	7		4
30527	connector three way 140° 54-42 with rings	8		2
30528	connector four way 140° 54-42 with rings	9		5
30529	connector four way 110° 54-42 with rings	10		10
30421	connector three way flat 54-42	11		4
30420	connector four way flat 54-42	12		10
30530	connector three way 54-42 endwallside right with ring	13		2
30531	foot three way 54-42 endwallside left with ring	14		2
30532	foot three way 54-42 sidewallside with ring	15		10
30424	foot two way 42-42	16		6

Contents

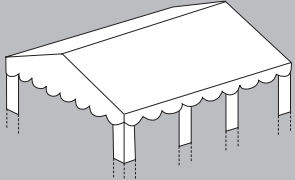
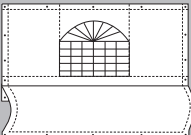
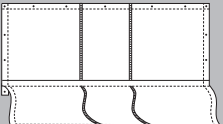
Part no.	Description	ID no.		8x12m
30622	stellwire buckle set for side	17		8
30534	stellwire buckle set for roof	18		12
30044	peg spiral	19		4
30046	ground peg 6x180 mm	20		20
30047	ground peg 4x160 mm	21		36
30430	bungee 14 cm	22		296
30429	bungee 5 cm	23		20
30050	guy rope 5 m	24		4
30051	roof hook	25		14
30382	spanner hex	26		1
30384	screw 30 mm	27		28
30404	screw 45 mm	28		100
30405	screw 65 mm	29		100
30052	wing nut	30		28
30535	locknut	31		200
30380	spanner	32		2
	roof	33		1
	side wall	34		12
	end wall	35		2

Instructions

1

Select a flat surface for the tent. Unpack the boxes and check if all listed parts are included.

Assemble the roof frame by mounting parts 7 to 12 on the pipes (parts 2 and 3). Use the screws to firmly attach the parts.

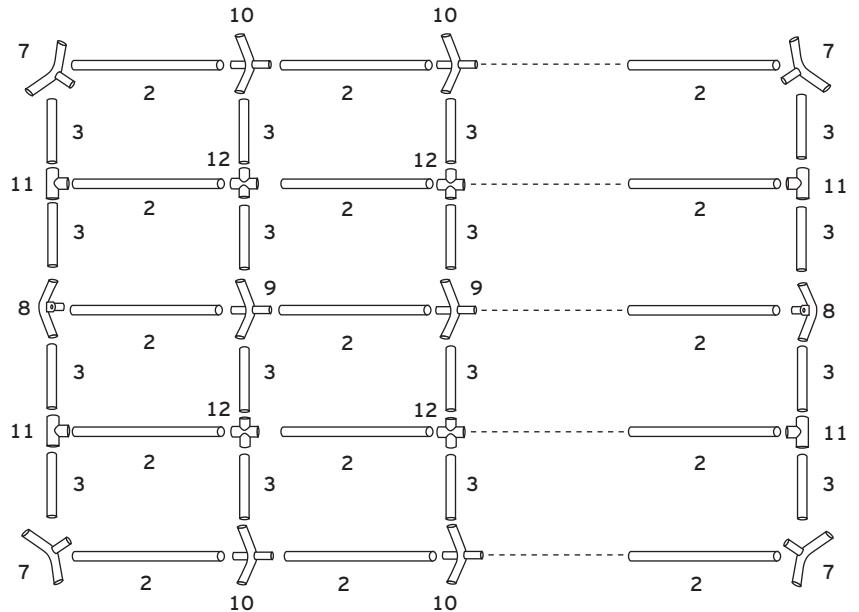

2

Attach the reinforcement braces (parts 4 and 5) using screws (27) and wing nuts (30).

Fastening the roof by using turnbuckle set (18) which is diagonally across through each two section as below.

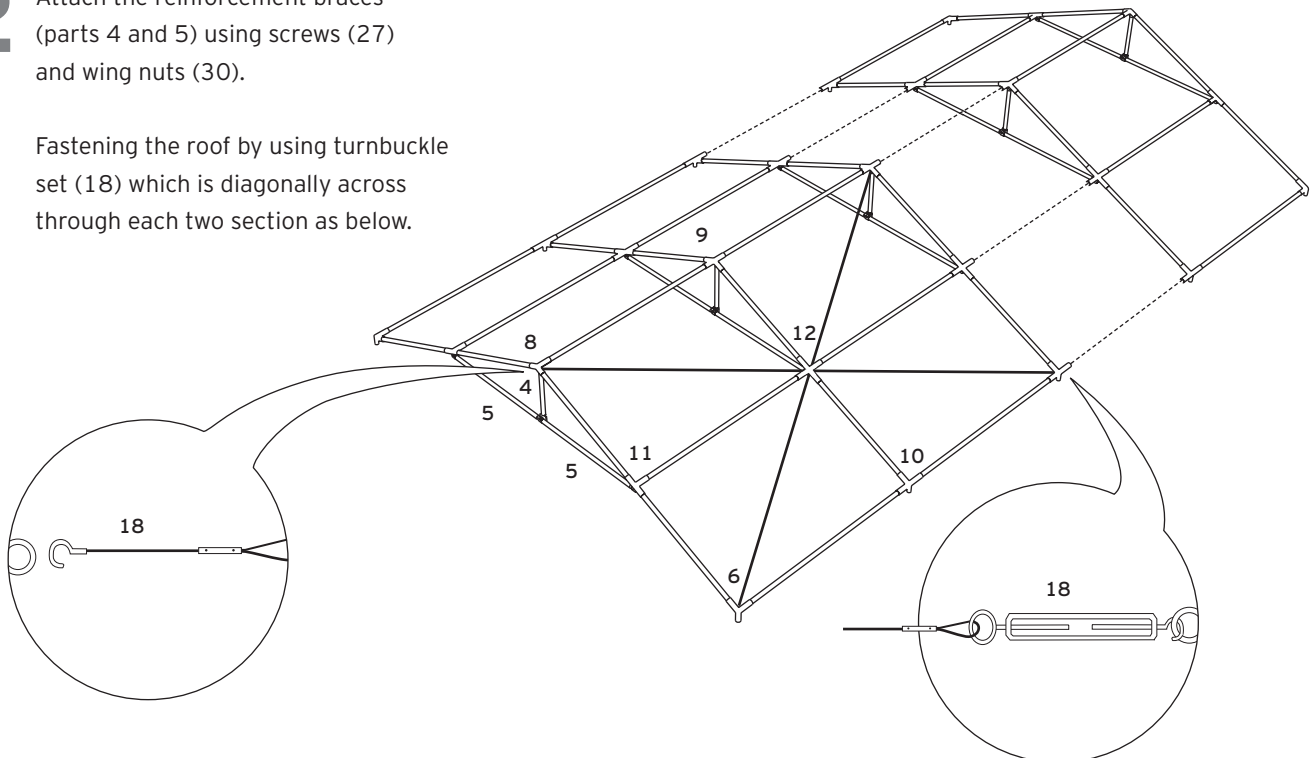

- 3** Lift one side of the tent frame and attach the legs (6). Place the roof (33) onto the frame and use the bungees (23) to fasten it. Be sure not to put too much tension on the bungees in order not to make attaching the other side more difficult.

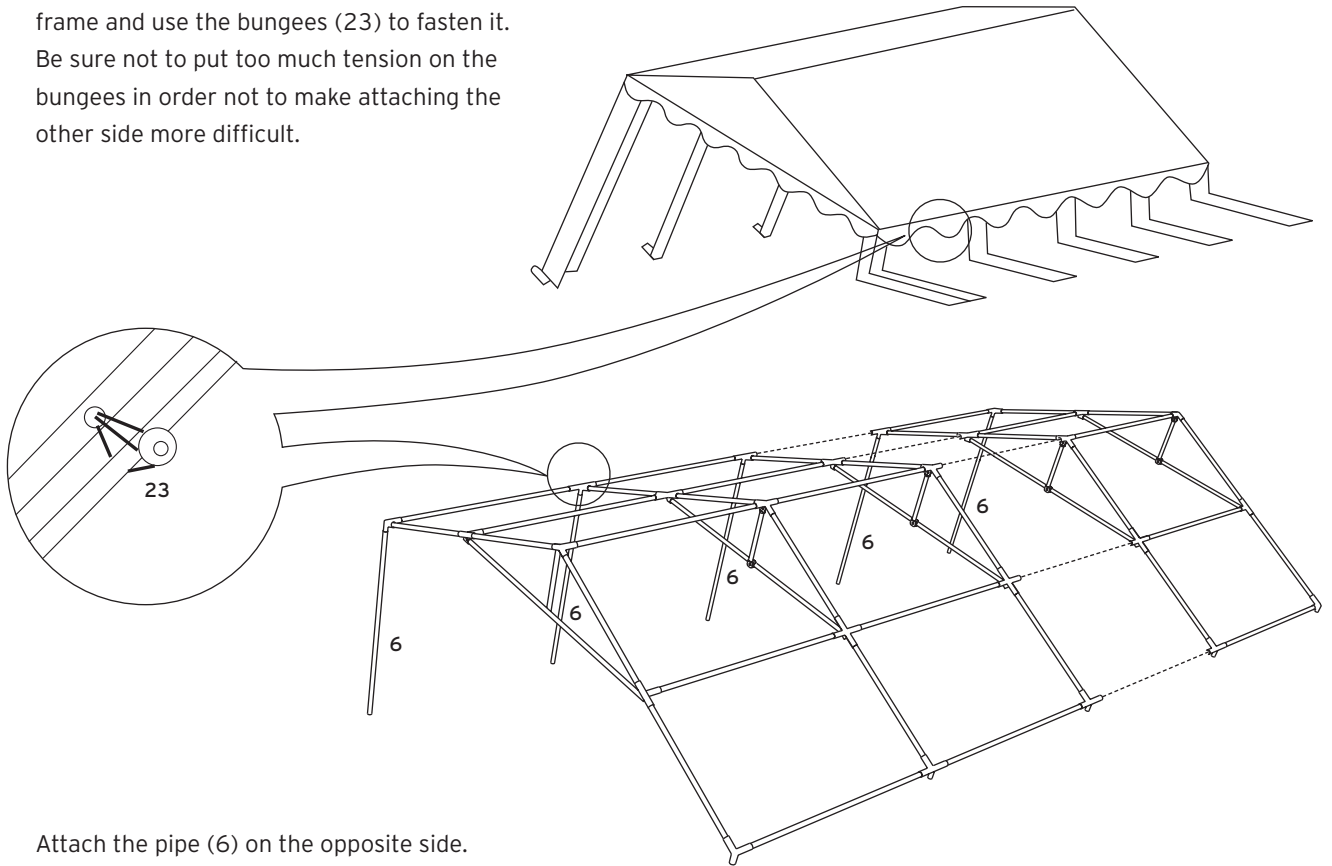

- 4** Attach the pipe (6) on the opposite side. Attach now on one side the pipe (1) to the pipe (6) and fix the feet on the ends (13/14/15). Then attach on the other side the pipe (1) to the pipe (6) and fix the feet on the ends (13/14/15).

The roof scarfs are fixed with the roof hooks (25) on pipe (1). With the steel wire buckle (17) you reinforce the side frame. Then complete the ground frame with the pipe (2) / connector (13/14/15/16).

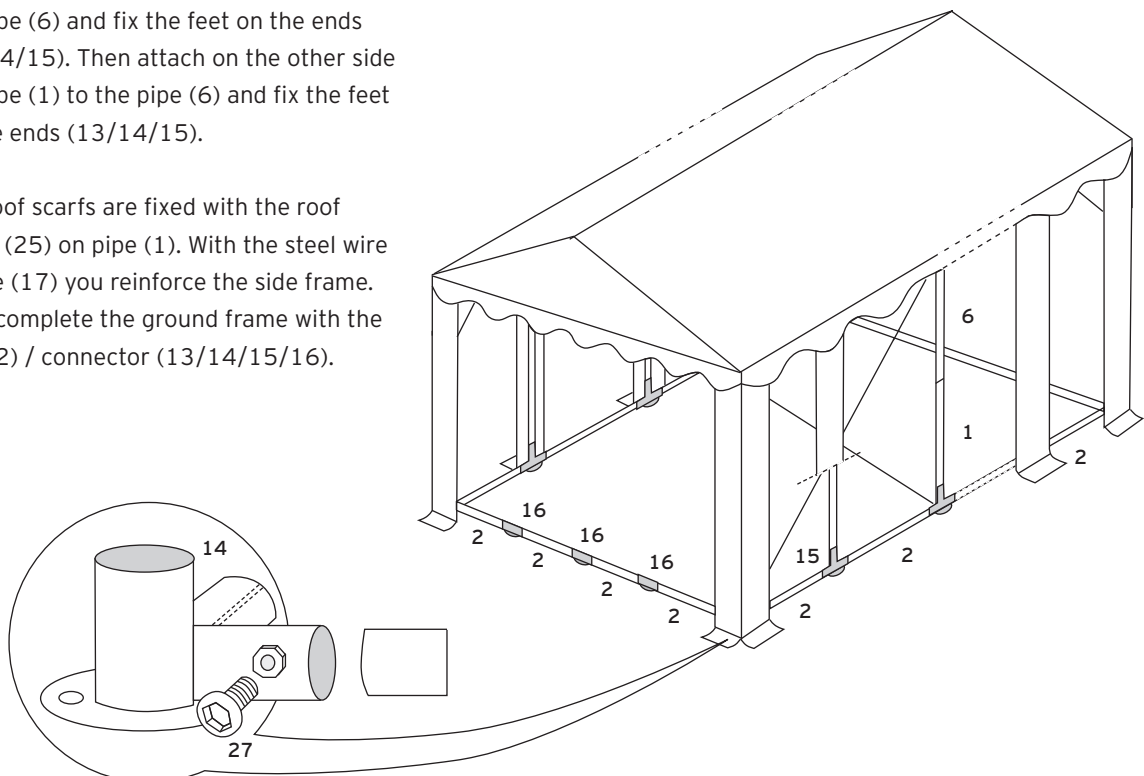

- 5** Extend the side walls (34) and the end walls (35) and attach the side walls to the frame using the bungees (22). Attach the end walls directly to the roof using the short bungees (23). Use the short ground pegs (21) to fasten the end walls to the ground. The guy rope runs from every corner of the tent and is braced to the ground using the screw hooks (19).

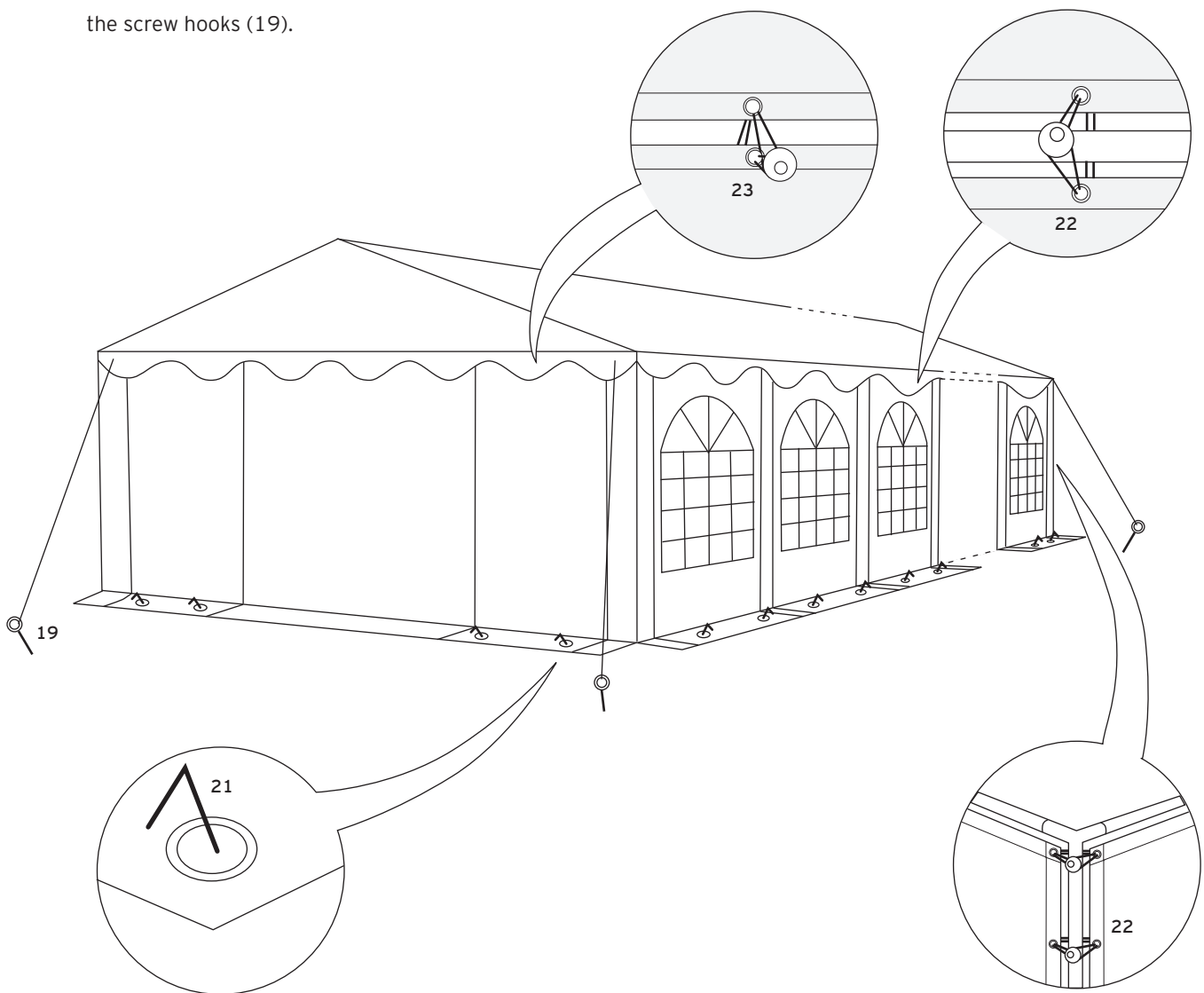

Cleaning and maintenance















Wash off the roof and the side parts with soapy water. Mould and mould stains can be removed using a mild chlorine solution. Observe the instructions provided by the manufacturer and test the chlorine solution on a hidden spot to make sure that there is no discolouration.

Caution! The party tent must not be collapsed and packed up when it is wet. First, allow it to dry completely.

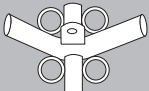





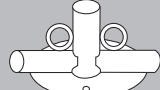
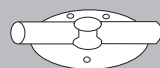





Caution

1. Always handle the tent with care to avoid damage.
2. Do not apply too much pressure to the frame parts to avoid damage.
3. Tents are intended for temporary accommodation and should be taken down in adverse weather conditions.
4. Always be sure to keep sufficient distance to hoses as well as gas and power lines to avoid possible damage.
5. When using suitable heaters (available e.g. in specialist shops), keep a minimum distance of 1.2 m to tarp material. Open fire or heaters with open flames such as patio heaters, umbrella heaters, gas heaters etc. should not be used in any case.
6. The person setting up the tent is responsible for adequately securing it to ensure its safety.

Zawartość

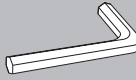
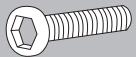
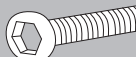
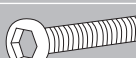
Nr kat.	Opis	Nr ID		8x12m
30672	drążek 1980 mm 50-50 z otworami	1		14
30522	drążek 1920 mm 38-38 z otworami	2		50
30523	drążek 1960 mm 50-50 z otworami	3		28
30524	drążek 750 mm wspornik dachu pionowy, seria 8	4		7
30525	drążek 1987 mm wspornik dachu poziomy, seria 8	5		14
30673	drążek 1980 mm 50-50 z 2 otworami	1		14
30526	łącznik narożny potrójny 110° 54-42 z przelotkami	6		4
30527	łącznik narożny potrójny 140° 54-42 z przelotkami	7		2
30528	łącznik narożny poczwórny 140° 54-42 z przelotkami	9		5
30529	łącznik narożny poczwórny 110° 54-42 z przelotkami	10		10
30421	trójnik 54-42	11		4
30420	czwórnik 54-42	12		10
30530	łącznik potrójny 54-42 do narożników, wersja prawa, z przelotką	13		2
30531	łącznik potrójny - stopka 54-42 do narożników, wersja prawa, z przelotką	14		2
30532	łącznik potrójny - stopka 54-42 do ścian bocznych, z przelotką	15		10
30424	łącznik potrójny - stopka 42-42	16		6

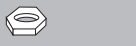
Zawartość

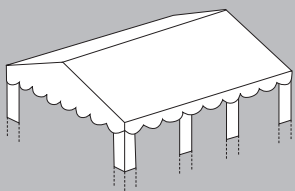
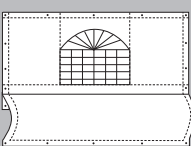
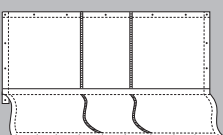
Nr kat.	Opis	Nr ID		8x12m
30622	napinacz z linką stalową do ścian bocznych	17		8
30534	napinacz z linką stalową do dachu	18		12
30044	hak wkręcany	19		4
30046	szpilka 6x180 mm	20		20
30047	szpilka 4x160 mm	21		36
30430	pętelka gumowa 14 cm	22		296
30429	pętelka gumowa 5 cm	23		20
30050	odciąg 5 m	24		4
30051	hak dachu	25		14
30382	klucz imbusowy	26		1
30384	śruba 30 mm	27		28
30404	śruba 45 mm	28		100
30405	śruba 65 mm	29		100
30052	nakrętka motylkowa	30		28
30535	nakrętka zabezpieczająca	31		200
30380	klucz płaski	32		2
	dachu	33		1
	ściana boczna	34		12
	ściana szczytowa	35		2

Instrukcja montażu

1 Wybierz płaską powierzchnię do rozstawienia namiotu. Rozpakuj kartony i sprawdź, czy zawierają wszystkie wymienione elementy.

Zmontuj ramę dachu. W tym celu połącz elementy 7 do 12 z drążkami (elementy 2 i 3). Skręć elementy mocno śrubami.

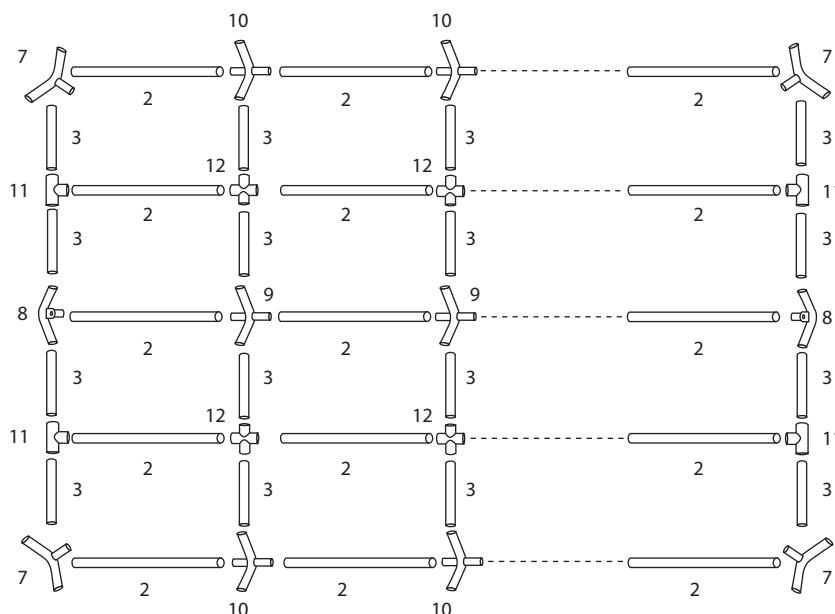

2 Za pomocą śrub (27) i nakrętek motylkowych (30) zamocuj wsporniki wzmacniające (elementy 4 i 5).

Za pomocą napinacza z linką (18), zamontowanego w poprzek każdej z obu sekcji (patrz niżej), ustabilizuj konstrukcję dachu.

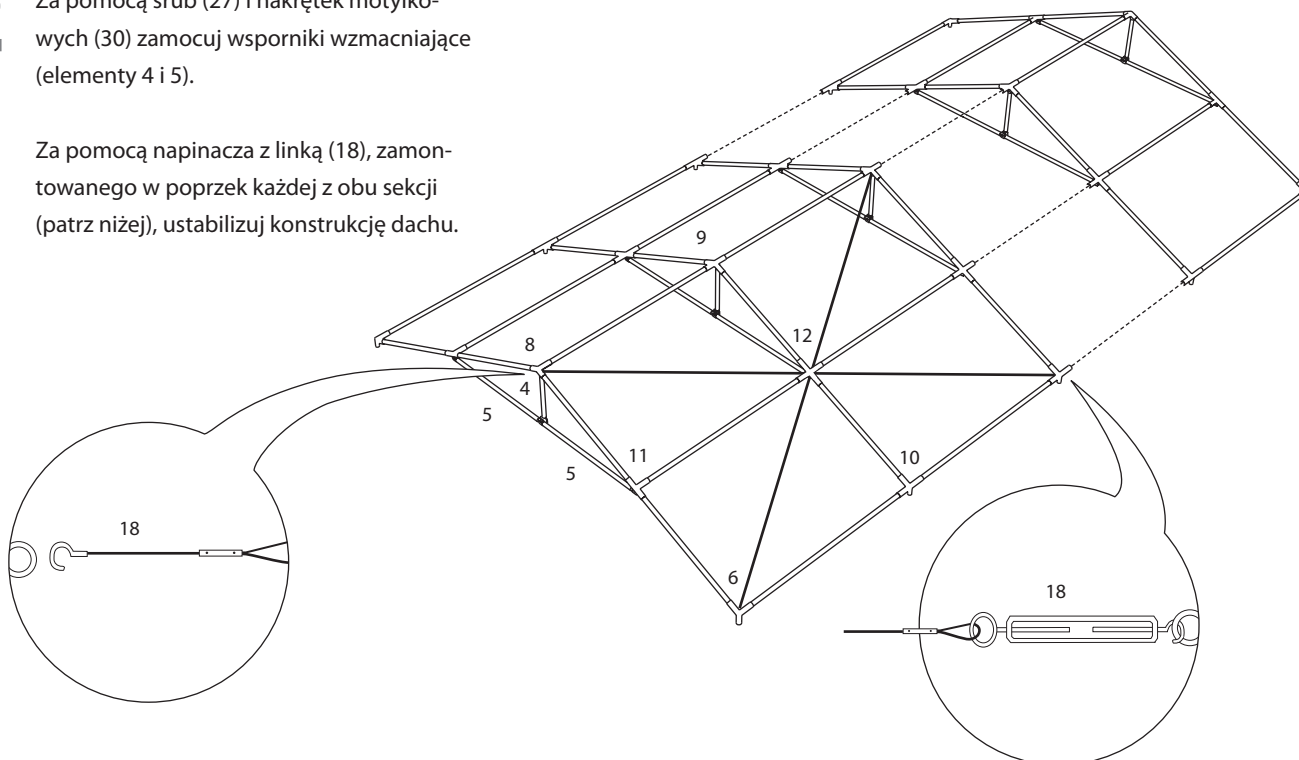

3 Podnieś jedną stronę stelaża namiotu i zamocuj nogi (6). Nałóż dach (33) na ramę i przymocuj go za pomocą gumowych pętelek (23). Uważaj, aby pętelki nie były za bardzo naprężone, może to utrudnić montaż drugiej strony namiotu.

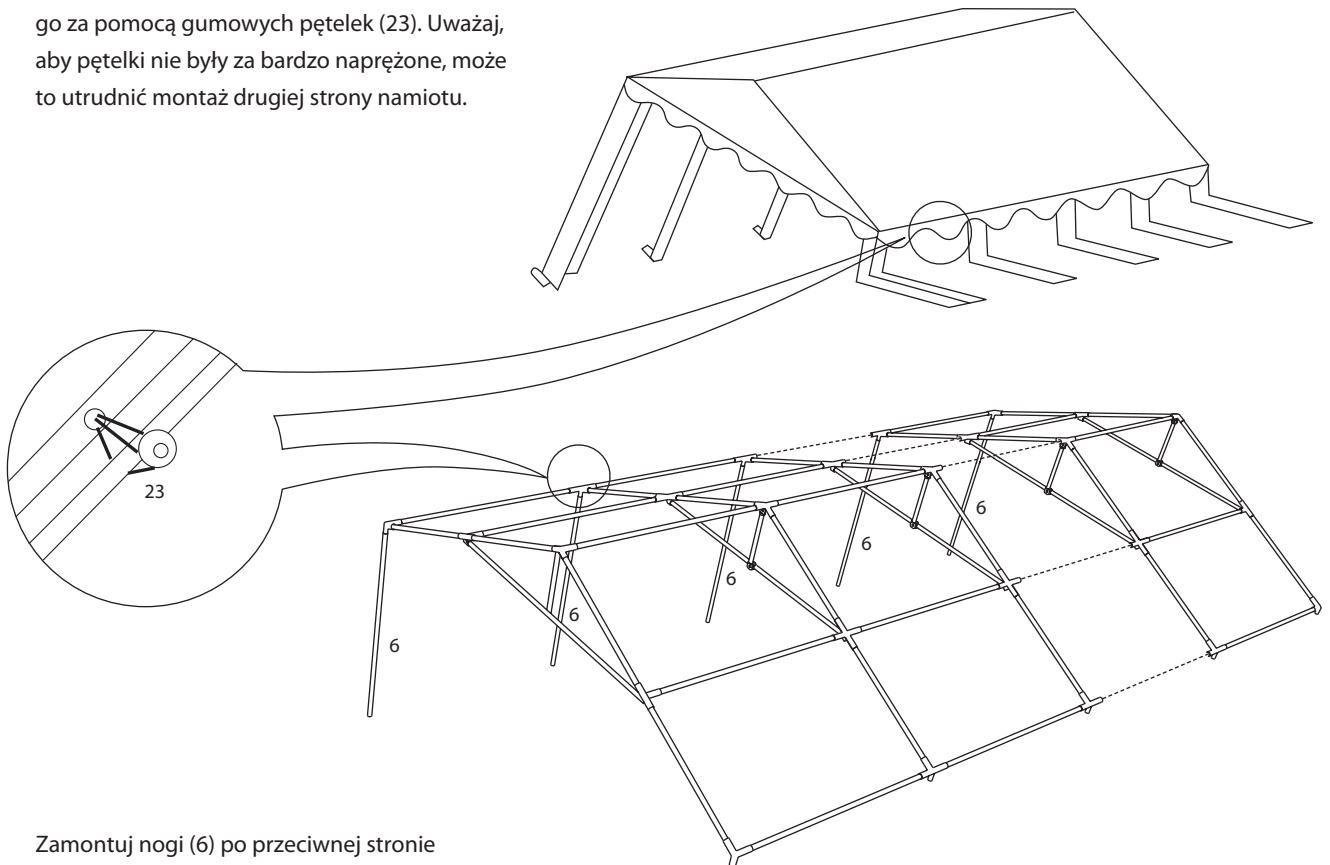

4 Zamontuj nogi (6) po przeciwnej stronie namiotu. Teraz połącz najpierw po jednej stronie namiotu drzązek (1) z drążkiem (6) a od spodu zamontuj stopki (13/14/15). Następnie połącz po drugiej stronie namiotu drzązek (1) z drążkiem (6). Przymocuj osłony boczne do drążków (1) za pomocą haków (25). Za pomocą elementów napinających (17) wzmocnij konstrukcję boczną namiotu. Następnie zamontuj ramę podstawy namiotu używając odpowiednich drążków (2) i łączników (13/14/15/16).

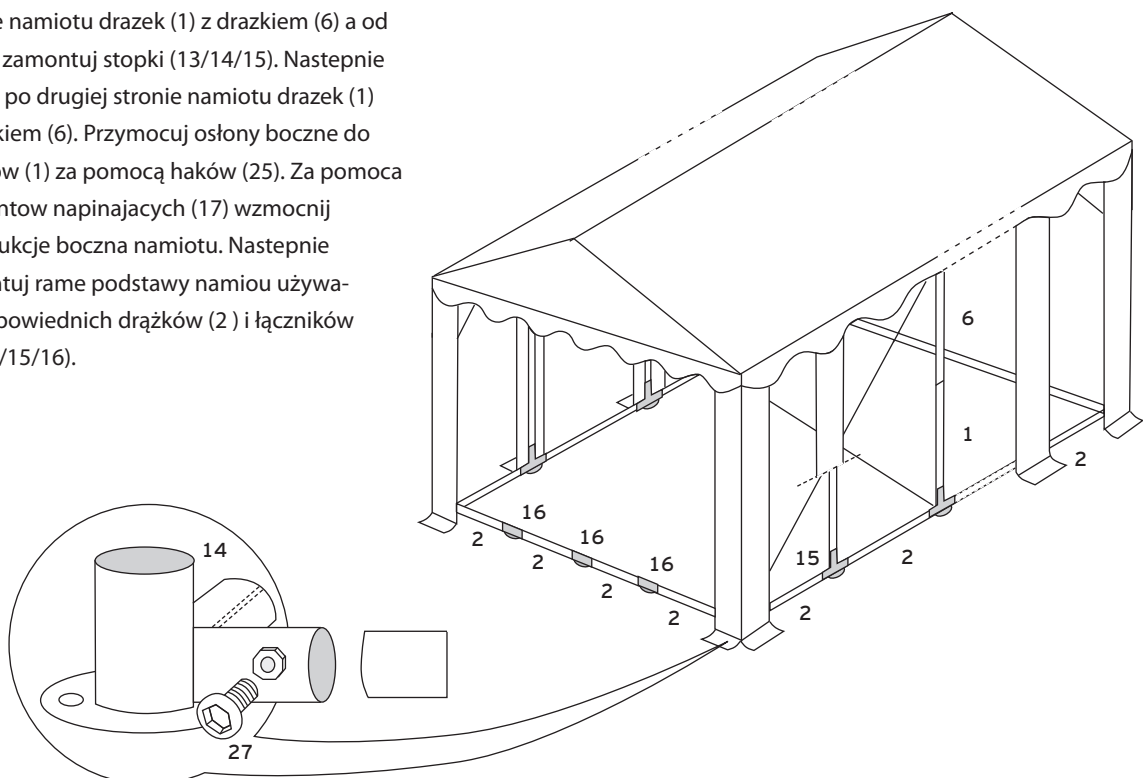

- 5** Rozwiń ściany boczne (34) i ściany szczytowe (35). Ściany boczne zamocuj do stelaża za pomocą gumowych pętelek (22), a ściany szczytowe za pomocą krótszych gumowych pętelek (23) bezpośrednio do dachu. Za pomocą krótszych szpilek (21) przymocuj ściany szczytowe do podłoża. W każdym narożniku namiotu naciągnij linkę naciągową i zamocuj ją do podłoża za pomocą haka wkręcane (19).

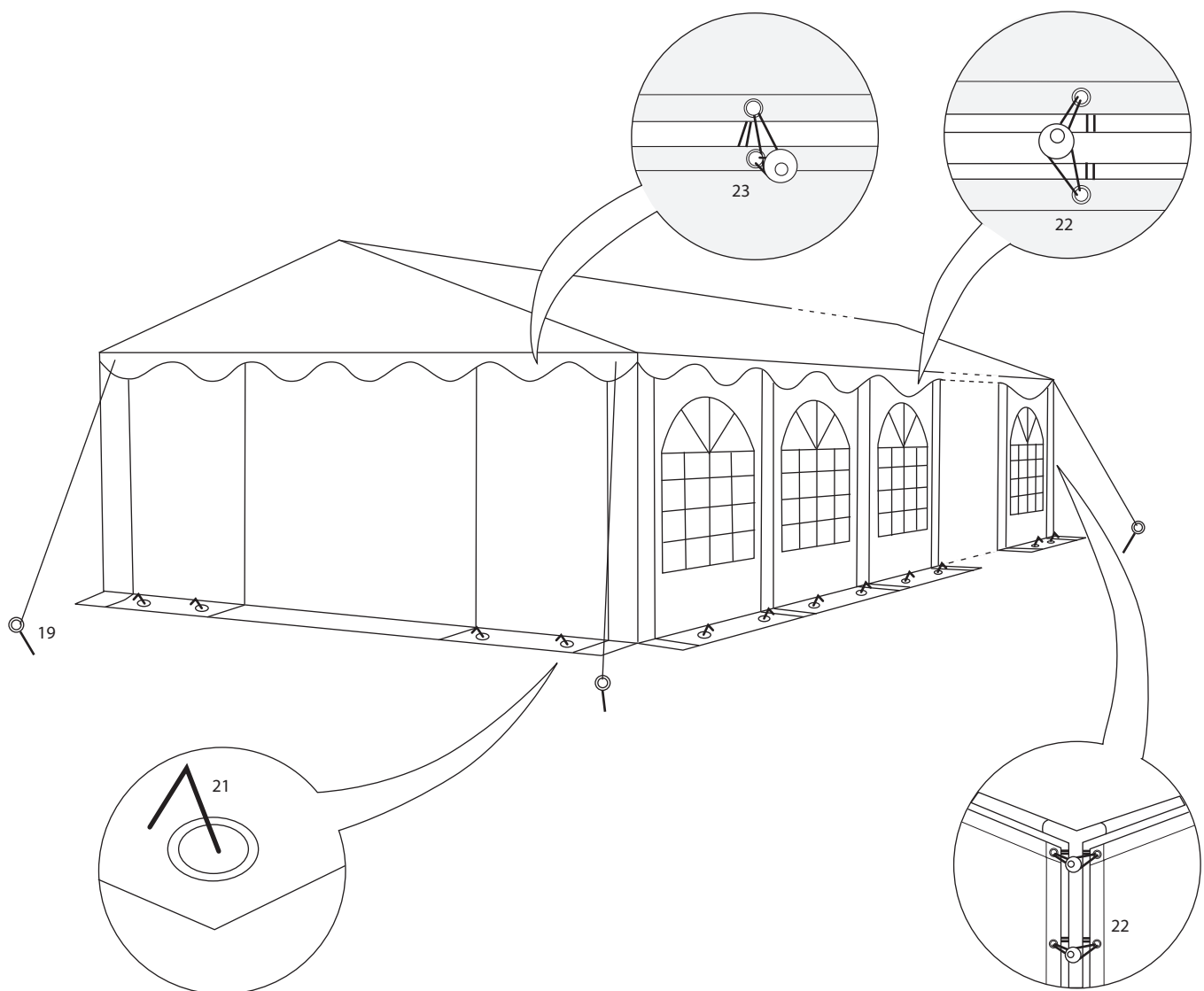

Czyszczenie i konserwacja















Dach i ściany boczne można myć wodą z mydłem. Ślady pleśni i plamy usuwać słabym roztworem chloru. Przestrzegać wskazówek producenta. Aby wykluczyć ryzyko powstania odbarwień, roztwór wypróbować najpierw w niewidocznym miejscu.

Uwaga! Nie wolno składać i pakować wilgotnego namiotu. Przed złożeniem namiot musi całkowicie wyschnąć.







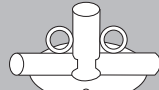
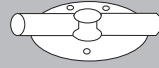



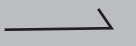

Ostrzeżenie

1. Należy zachować ostrożność podczas rozstawiania i składania namiotu, aby uniknąć jego uszkodzenia.
2. Stelaża nie narażać na zbyt duże obciążenia, ponieważ mogłoby to spowodować jego uszkodzenie.
3. Namioty są przeznaczone do użytku czasowego i w przypadku niesprzyjających warunków atmosferycznych należy je zdemontować.
4. Namiot rozstawiać w odpowiedniej odległości od przewodów wodnych, gazowych i elektrycznych, aby ich nie uszkodzić.
5. W przypadku używania odpowiednich grzejników (np. poprosić o radę sprzedawcę) należy je ustawiać w odległości nie mniejszej niż 1,2 metra od plandeki. Pod żadnym pozorem nie wolno używać otwartego ognia ani grzejników z otwartym płomieniem, np. parasoli grzewczych, promienników ogrodowych, nagrzewnic gazowych itp.
6. Osoba rozstawiająca namiot jest odpowiedzialna za jego właściwe przytwierdzenie do podłoża i tym samym za bezpieczeństwo.

Inhoud

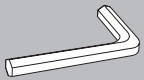
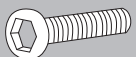
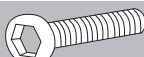
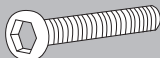
Artikelnr.	Beschrijving	ID nummer		8x12m
30672	stang 1980 mm 50-50 met gaten	1		14
30522	stang 1920 mm 38-38 met gaten	2		50
30523	stang 1960 mm 50-50 met gaten	3		28
30524	stang 750 mm dakversterking 8-serie verticaal	4		7
30525	stang 1987 mm dakversterking 8-serie horizontaal	5		14
30673	Stange 1980 mm 50-50 met 2 gaten	6		14
30526	3-voud. verbinding 110° 54-42 met ringen	7		4
30527	3-voud. verbinding 140° 54-42 met ringen	8		2
30528	4-voud. verbinding 140° 54-42 met ringen	9		5
30529	4-voud. verbinding 110° 54-42 met ringen	10		10
30421	3-voud. verbinding vlak 54-42	11		4
30420	4-voud. verbinding vlak 54-42	12		10
30530	3-voud. verbinding 54-42 Eindwand rechts met ring	13		2
30531	Voet drieweg 54-42 Eindwand links met ring	14		2
30532	Voet drieweg 54-42 Zijwand met ring	15		10
30424	Voet drieweg 42-42	16		6

Inhoud

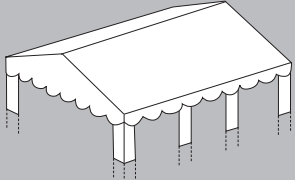
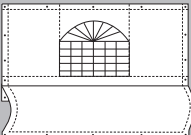
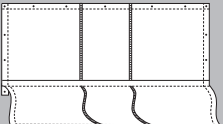
Artikelnr.	Beschrijving	ID nummer		8x12m
30622	Stellwire gordelset zijkant	17		8
30534	Stellwire gordelset dak	18		12
30044	Aardpen spiraal	19		4
30046	Aardpen 6x180 mm	20		20
30047	Aardpen 4x160 mm	21		36
30430	Elastiek 14 cm	22		296
30429 5 cm	Elastiek	23		20
30050	Spanlijn 5 m	24		4
30051	Dakhaken	25		14
30382	Sleutel	26		1
30384	Schroef 30 mm	27		28
30404	Schroef 45 mm	28		100
30405	Schroef 65 mm	29		100
30052	Vleugelmoer	30		28
30535	Borgmoer	31		200
30380	Spanner	32		2
	Dak	33		1
	Zijkant	34		12
	Eindwand	35		2

Instructies

1

Selecteer een egale ondergrond voor de tent. Pak de dozen uit en controleer of alle onderdelen aanwezig zijn.

Stel het dakframe samen door delen 7 tot 12 aan de stangen te monteren (delen 2 en 3). Gebruik de schroeven om de delen te bevestigen.

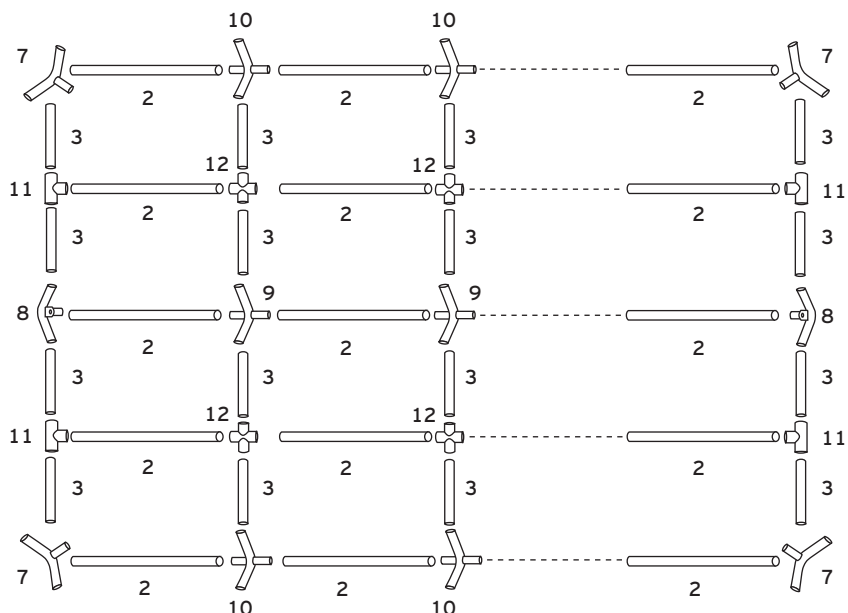

2

Bevestig de versterkingsstijlen (delen 4 en 5) met schroeven (27) en vleugelmoeren (30).

Bevestig het dak met behulp van spanschroefset (18), die diagonaal telkens over twee secties komt zoals afgebeeld.

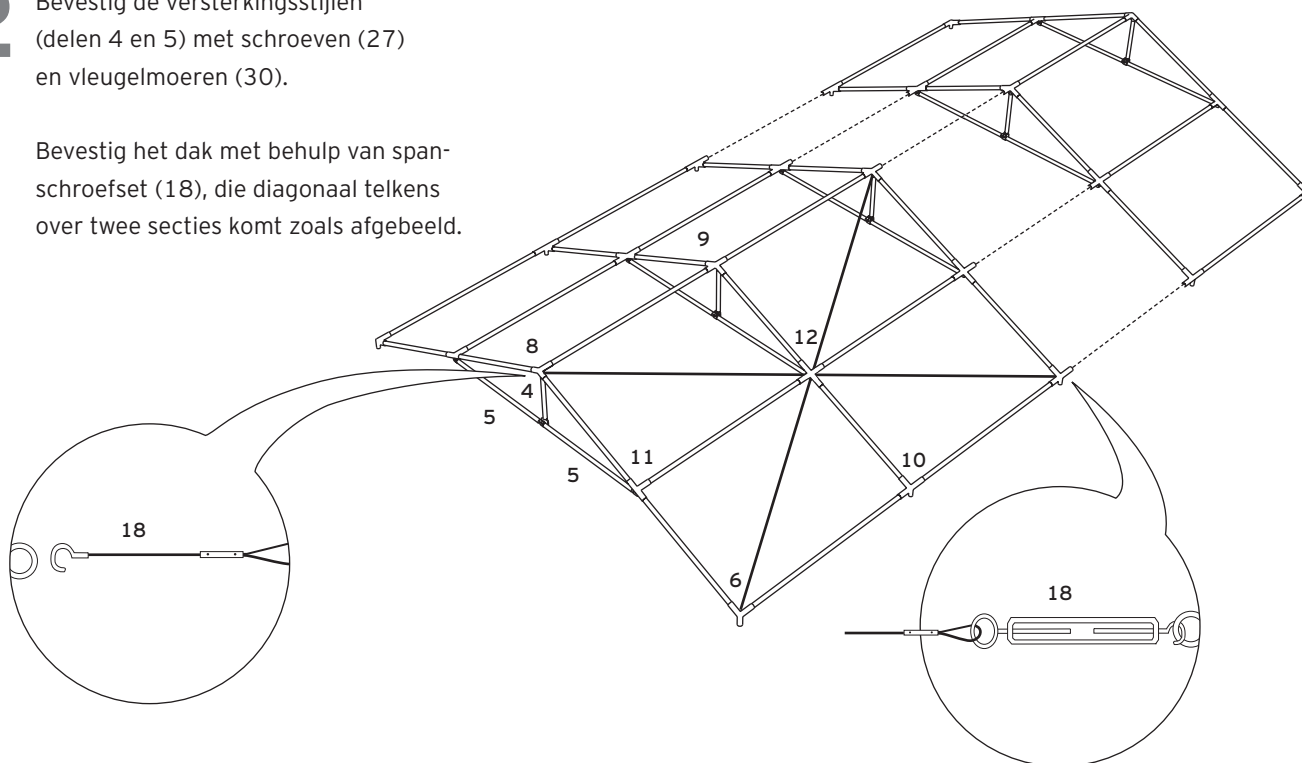

3 Til één zijde van het tentframe op en breng de benen (6) aan. Breng het dak (33) aan op het frame en bevestig het met de rubberen lussen (23). Let er op de rubberen lussen niet te strak te spannen, om het aanbrengen van de andere zijde niet te bemoeilijken.

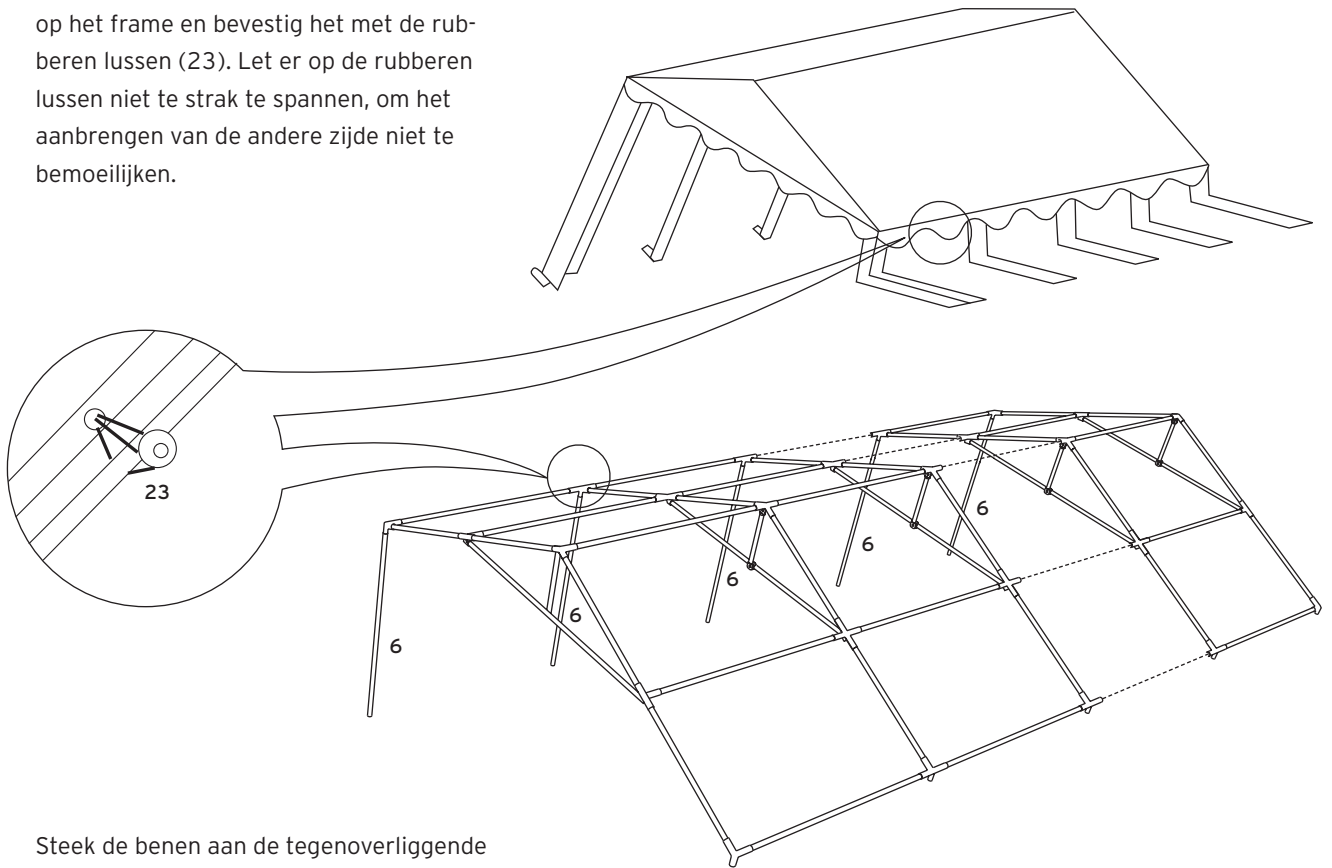

4 Steek de benen aan de tegenoverliggende zijde in en monteer de voeten (12, 13, 14) aan de onderzijde. Gebruik de lange aardpennen (20) om de voeten aan de grond te bevestigen. Bevestig de zijkanten aan de stangen (1) met behulp van de haken (25). Gebruik de spannersets (16) om de structuur te bevestigen, net als bij het dak. Vervolledig het bodemframe met de vereiste stangen (2 en 3) en verbinding (15).

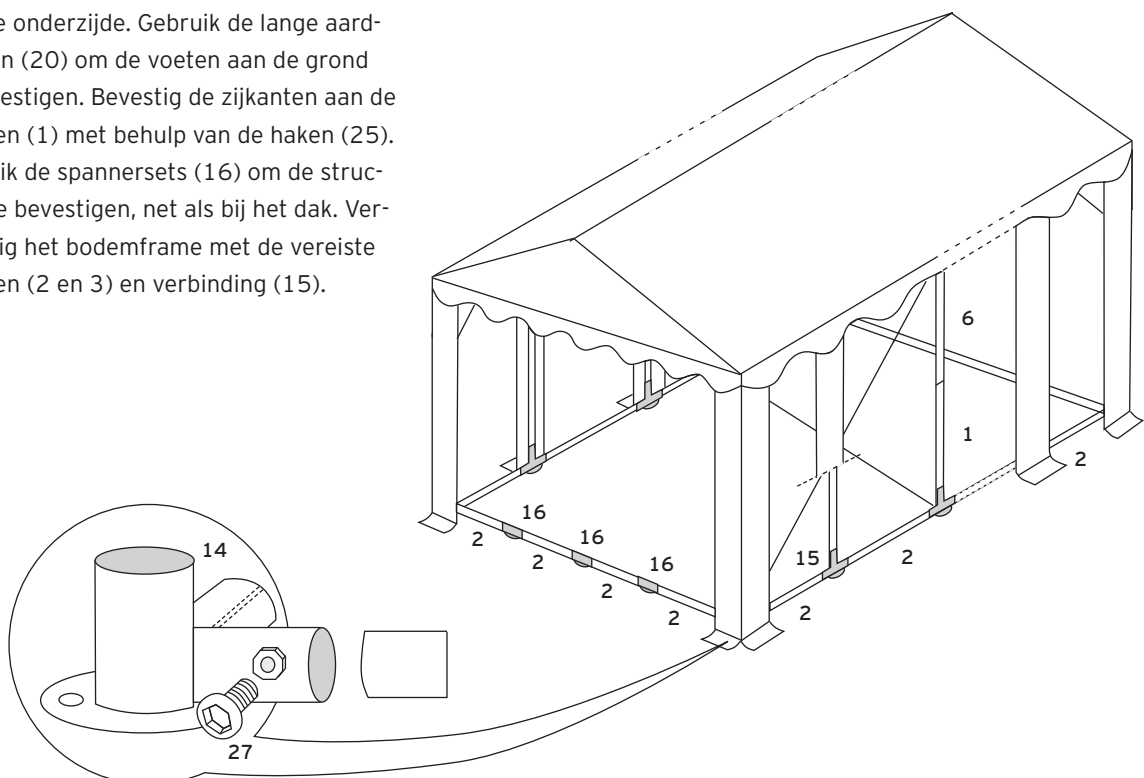

- 5** Neem de zijkanten (34) en de eindkanten (35) en bevestig de zijkanten aan het frame met de rubberen lussen (22). Bevestig de eindkanten direct aan het dak met de korte rubberen lussen (23). Gebruik de korte aardpennen (21) om de eindkanten aan de grond te bevestigen. Het spantouw loopt over elke hoek van de tent, en wordt naar de grond gebracht met de schroefhaken (19).

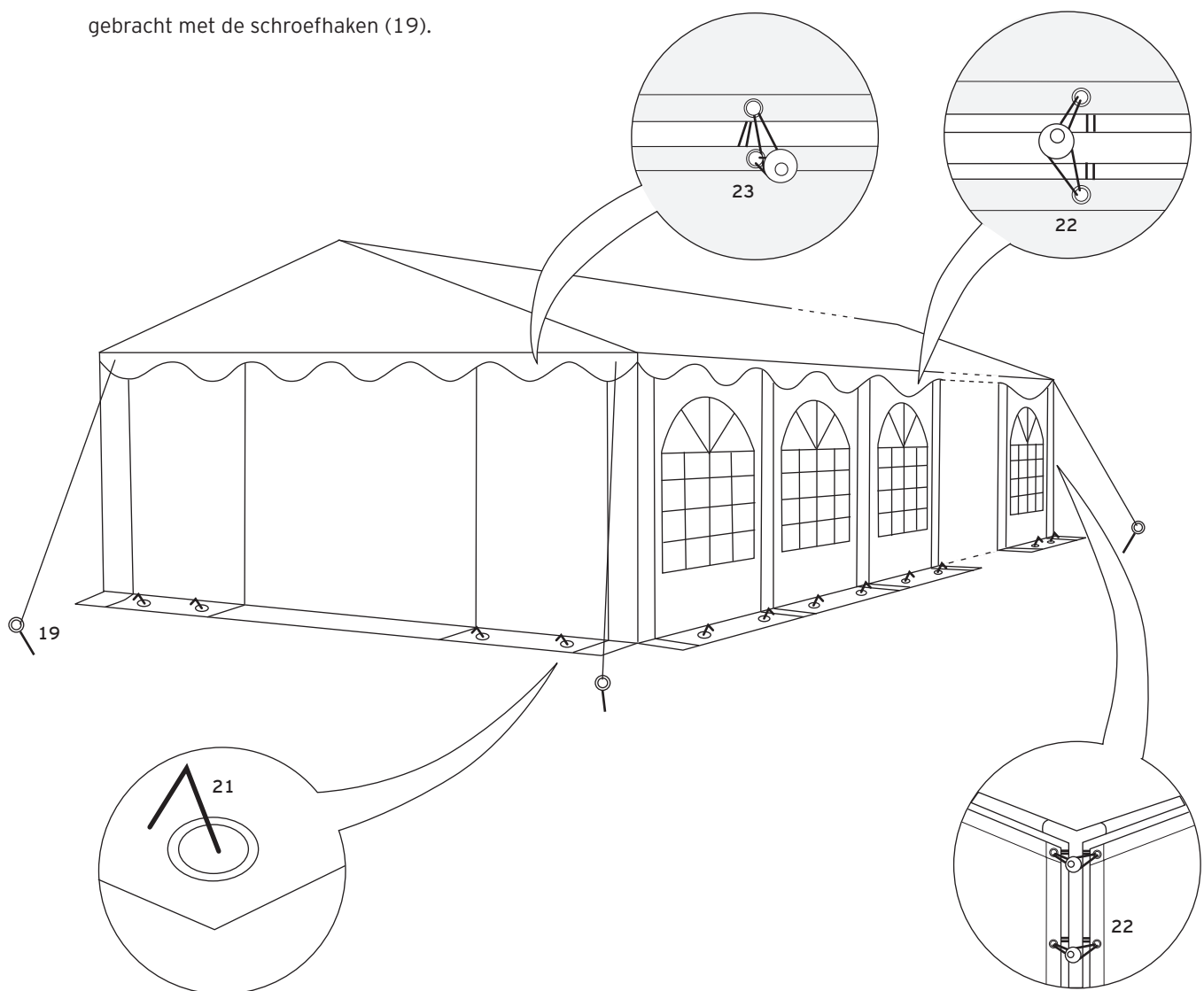

Reiniging en onderhoud















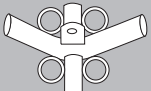

Dak en zijdelen kunnen met een zeepsopje worden afgewassen. Schimmels en vochtvlekken verwijdt u met een zachte chlooroplossing. Volg de aanwijzingen van de fabrikant op, en test de chlooroplossing op een niet zichtbare plaats, om zeker te zijn dat er geen verkleuring optreedt.

Let op! De partytent mag niet in natte toestand worden gedemonteerd en verpakt. Laat haar voordien volledig opdrogen.





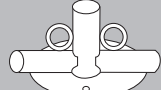



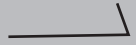

Waarschuwing

1. Let er op de tent voorzichtig te behandelen, om defecten te vermijden.
2. Niet te veel kracht gebruiken bij het hanteren van de stangen: ze kunnen anders beschadigd raken.
3. Tenten zijn bedoeld als tijdelijke beschutting en moeten bij slechte weersomstandigheden gedemonteerd worden.
4. Zorg steeds voor een aangepaste afstand tot slangen, gas- en elektriciteitsleidingen, om deze niet te beschadigen.
5. Bij gebruik van een geschikt verwarmingsapparaat (zie voor nadere informatie de vakhandel) moet een afstand van minstens 1,2 m tot om het even welk vlak worden aangehouden. Open vuur en verwarmingsapparaten met open vlam zoals terrasverwarmingen, gaskachels e.d. mogen in geen geval worden gebruikt.
6. De bouwer is verantwoordelijk voor een aangepaste verankering en daarmee voor de veiligheid van de tent.

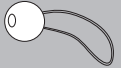
Contenu

Code art.	Description	N° de repère		8 x 12 m
30672	Tube 1980 mm 50-50 avec trous	1		14
30522	Tube 1920 mm 38-38 avec trous	2		50
30523	Tube 1960 mm 50-50 avec trous	3		28
30524	Tube 750 mm Tirant de toit série 8 vertical	4		7
30525	Tube 1987 mm Tirant de toit série 8 horizontal	5		14
30673	Tube 1980 mm 50-50 avec 2 trous	6		14
30526	Raccord trois axes 110° 54-42 avec anneaux	7		4
30527	Raccord trois axes 140° 54-42 avec anneaux	8		2
30528	Raccord quatre axes 140° 54-42 avec anneaux	9		5
30529	Raccord quatre axes 110° 54-42 avec anneaux	10		10
30421	Té 54-42	11		4
30420	Croisillon 54-42	12		10
30530	3 Raccord trois axes 54-42 pied pour les coins droit avec anneau	13		2
30531	Raccord 3 axes 54-42 pied pour les coins gauche avec anneau	14		2
30532	Raccord 3 axes 54-42 pied pour les parois latérales	15		10
30424	Raccord 2 axes 42-42	16		6

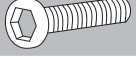
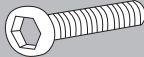
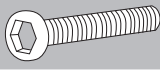
Contenu

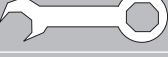
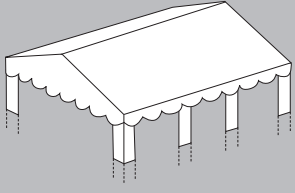
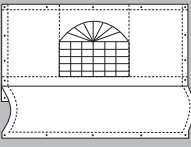
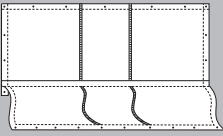
Code art.	Description	N° de repère		8 x 12 m
30622	Ensemble boucle en fil d'acier pour côté	17		8
30534	Ensemble boucle en fil d'acier pour toit	18		12
30044	Crochet à visser	19		4
30046	Piquet de sol 6 x 180 mm	20		20
30047	Piquet de sol 4 x 160 mm	21		36
30430	Boucle caoutchouc 14 cm	22		296
30429	Boucle caoutchouc 5 cm	23		20
30050	Cordeau tendeur 5 m	24		4
30051	Crochet de toit	25		14
30382	Clé de serrage hexagonale	26		1
30384	Vis 30 mm	27		28
30404	Vis 45 mm	28		100
30405	Vis 65 mm	29		100
30052	Écrou à oreilles	30		28
30535	Écrou de serrage	31		200
30380	Clé de serrage	32		2
	Toit	33		1
	Paroi latérale	34		12
	Paroi d'extrémité	35		2

Mode d'emploi

1

Cherchez un endroit où le sol est plan pour installer la tente. Déballez les cartons et vérifiez que toutes les pièces figurant dans la liste ci-dessus sont présentes.

Assemblez le cadre du toit en montant les pièces 7 à 12 sur les tubes (pièces 2 et 3). Bien fixez les tirants de renfort au moyen des vis.

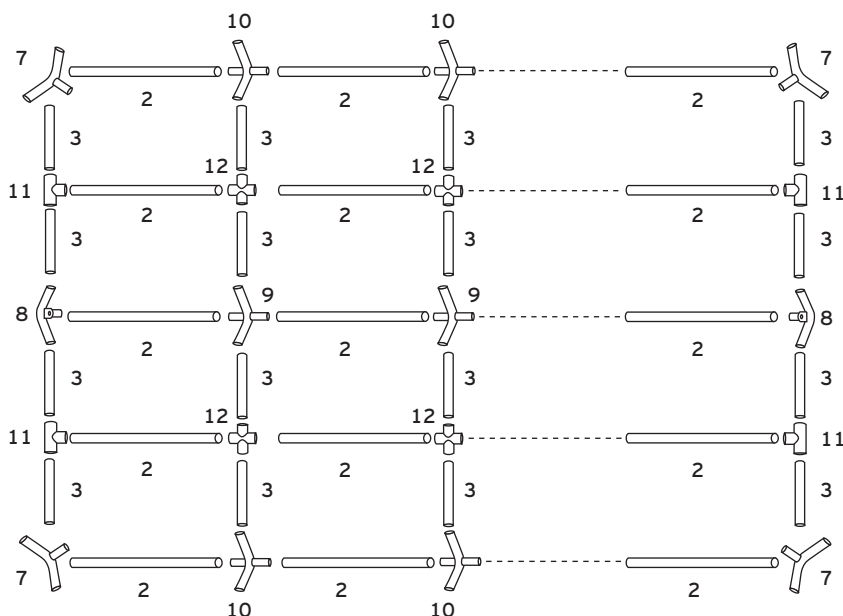

2

Fixez les renforts (pièces 4 et 5) au moyen des vis (27) et des écrous à ailettes (30).

Accrochez le toit en utilisant le système à tendeur à lanterne (18) situé en diagonal dans chacune des deux parties du toit comme décrit ci-dessous.

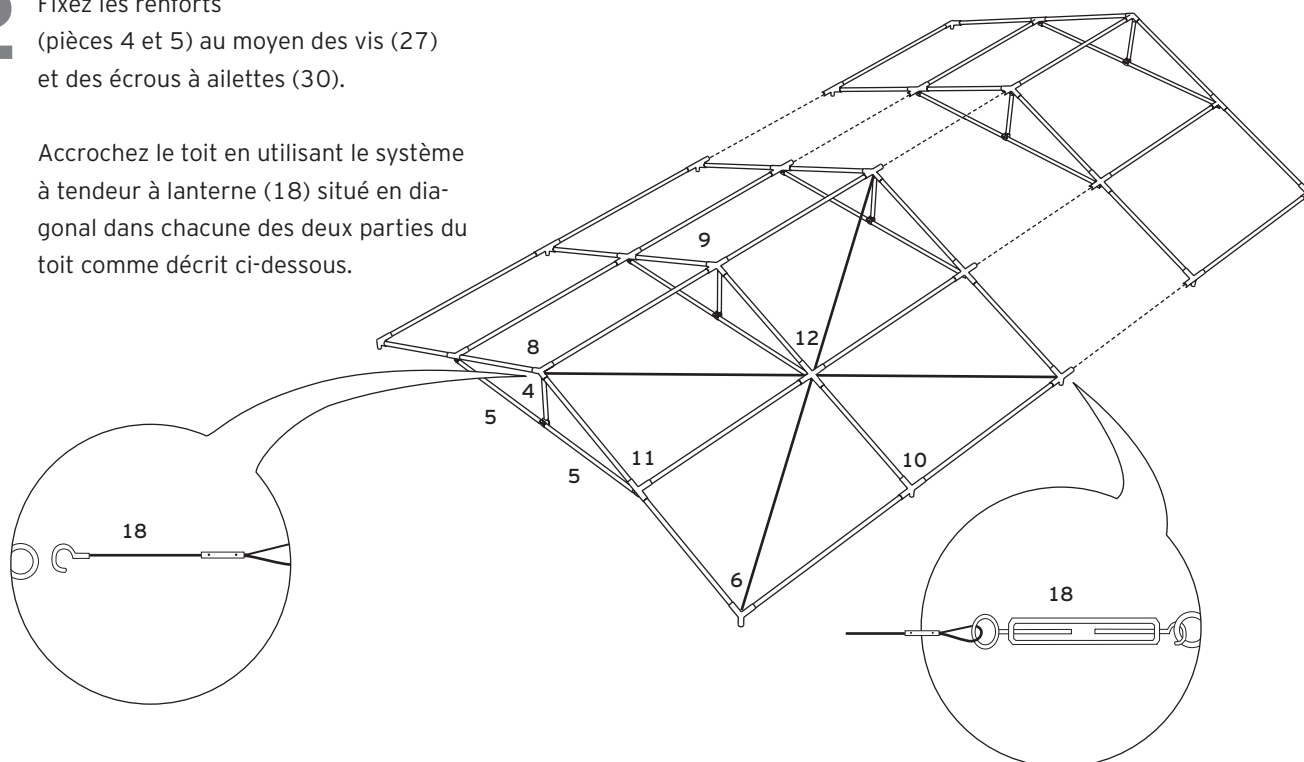

3 Soulevez un côté de l'ossature de la tente et emmanchez les montants (6). Posez le toit (33) sur le cadre et fixez-le au moyen des boucles en caoutchouc (23). Évitez de tendre exagérément les boucles en caoutchouc afin de ne pas rendre le montage de l'autre côté plus difficile.

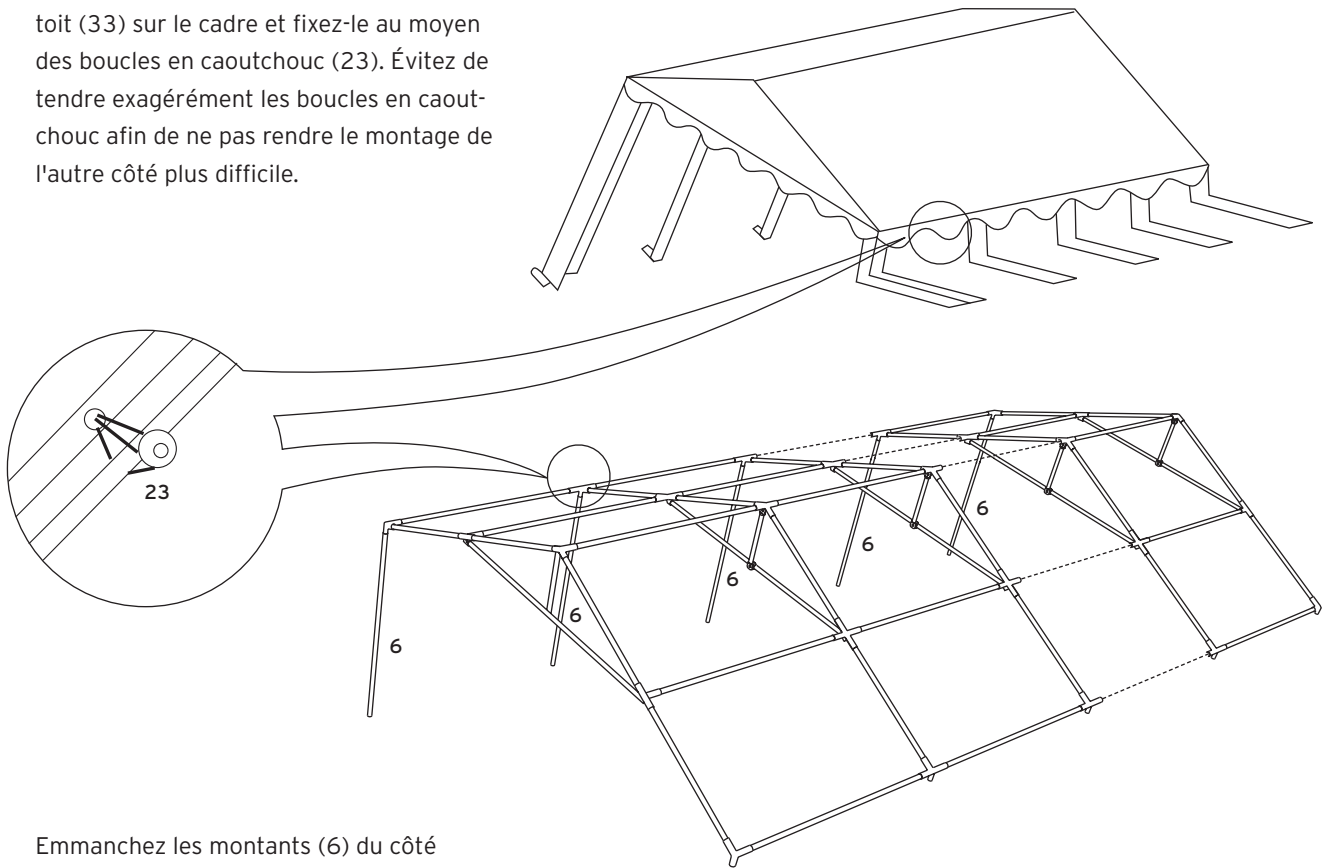

4 Emmanchez les montants (6) du côté opposé. Commencez par un côté de mettre les tubes (1) sur les tubes (6) et puis montez les pieds (13, 14, 15) à leur extrémités inférieures. Après continuez sur le côté opposé.

L'habillage du toit se fixe aux tubes(1) au moyen de crochets (25). Fixez la structure à l'aide des systèmes à tendeur à lanterne (17) comme vous l'avez fait avec le toit. Finissez de monter le cadre inférieur avec les tubes (2) et les raccords (13/14/15/13) correspondants.

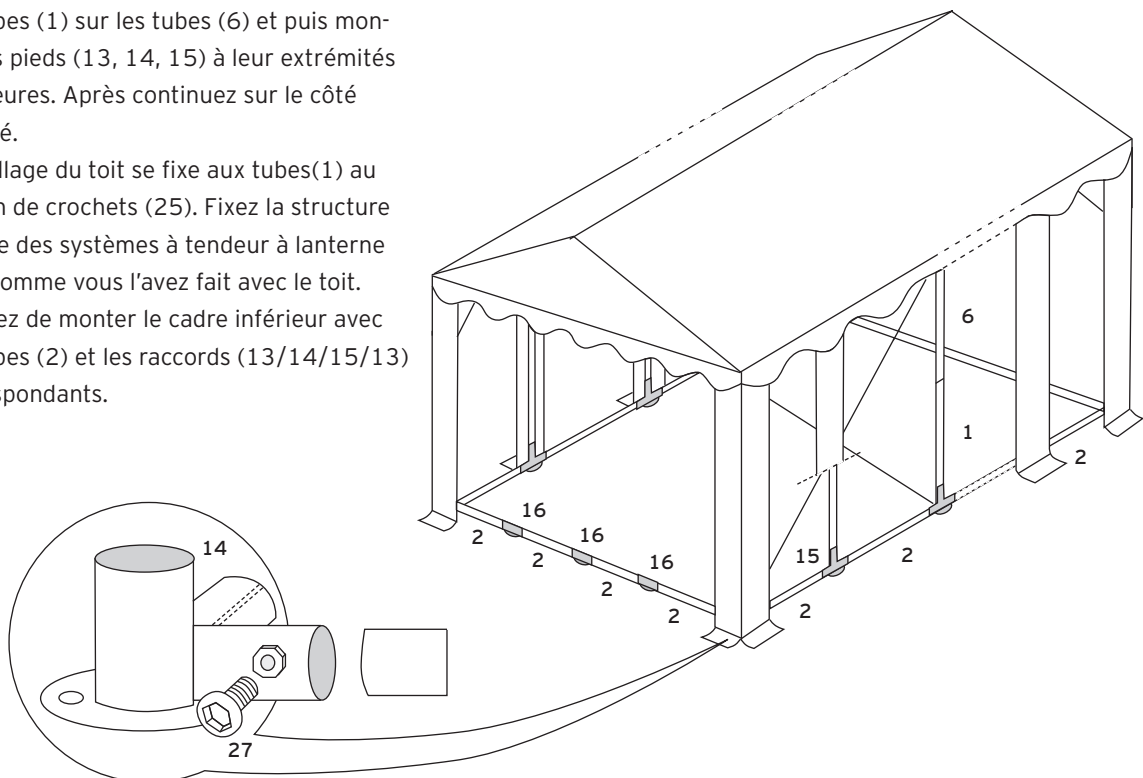

- 5** Écartez les parois latérales (34) et les parois d'extrémité (35) et fixez les parois latérales à l'ossature au moyen des boucles en caoutchouc (22). Fixez les parois d'extrémité directement au toit au moyen des boucles courtes (23). Fixez les parois d'extrémité au sol à l'aide des piquets courts (21). Le cordeau tendeur part de chaque angle de la tente et il est tendu au sol au moyen des crochets à visser (19).

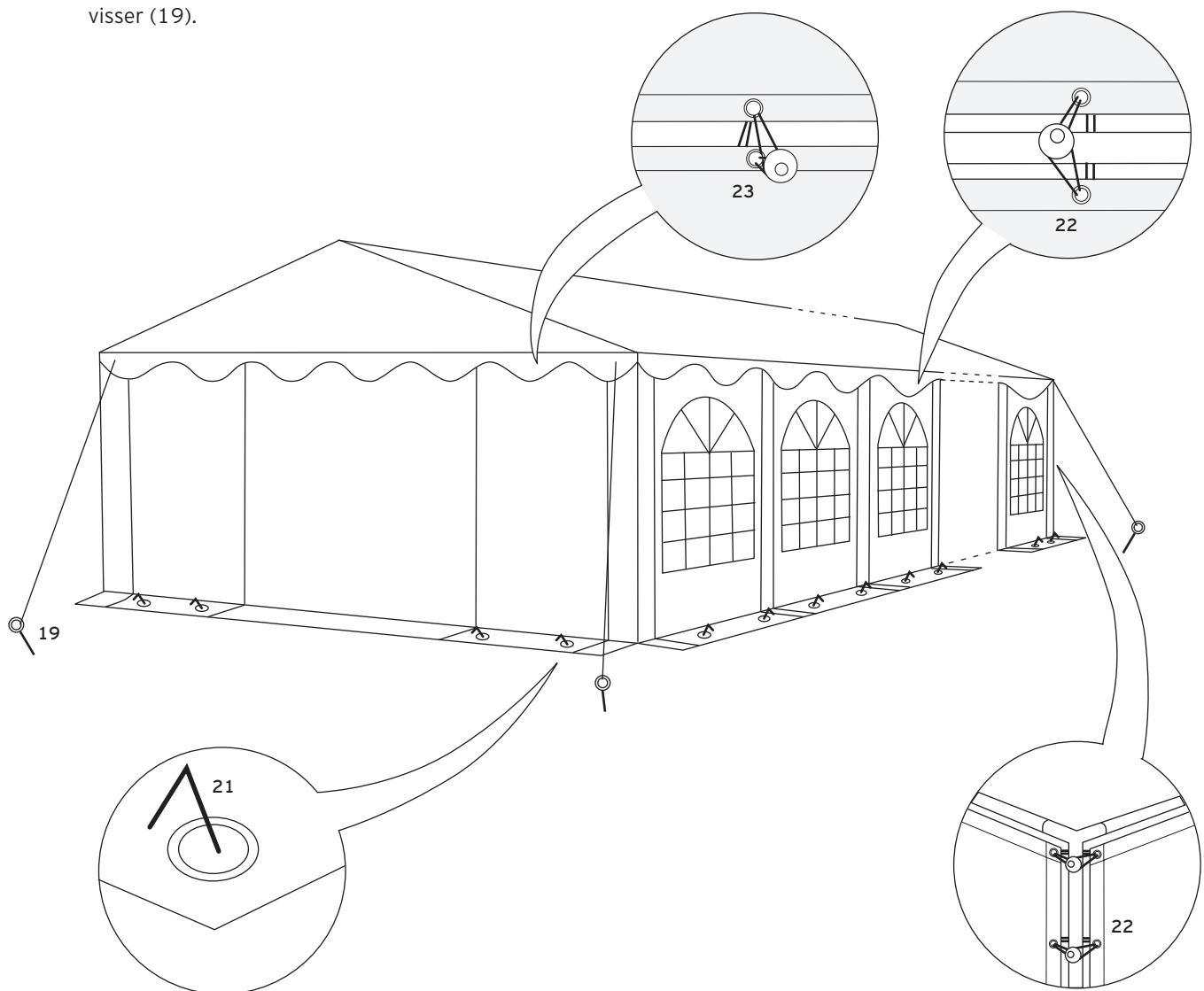

Nettoyage et entretien











Le toit et les parois se lavent à l'eau savonneuse. Pour éliminer les moisissures et les taches d'humidité, utilisez une solution légèrement chlorée. Suivez les instructions du fabricant et testez la solution chlorée à un endroit non visible pour vous assurer qu'elle ne provoque pas de décoloration.

Attention ! La tente de réception ne doit en aucun cas être repliée et rangée lorsqu'elle est humide. Laissez-la sécher complètement auparavant.





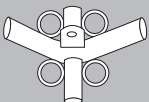
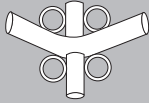

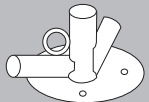
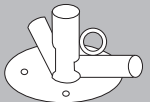
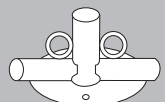
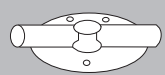



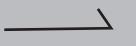
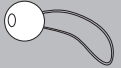

Avertissements

1. Veillez à manipuler la tente avec précautions pour éviter de la détériorer.
2. Évitez de forcer sur les tubes et les raccords, au risque de les endommager.
3. Les tentes sont destinées à des usages de loisirs temporaires et elles doivent être démontées en cas de mauvais temps.
4. Veillez à respecter systématiquement une distance appropriée par rapport aux tuyaux, aux conduites de gaz ou aux lignes électriques afin d'éviter de les endommager.
5. En cas d'utilisation d'appareils de chauffage adaptés (se renseigner par exemple auprès d'un vendeur spécialisé), respectez une distance minimum de 1,2 m par rapport à chaque matériau de bâchage. Les feux ouverts de même que les appareils de chauffage à flammes nues tels que champignons chauffants, radiateurs de terrasses, chauffages au gaz etc. ne doivent en aucun cas être utilisés.
6. L'installateur est responsable de l'ancrage adéquat et donc de la sécurité de la tente.

Obsah

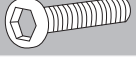
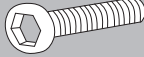
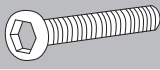
Č. výrobku	Popis	ID číslo		8 × 12 m
30672	Tyč 1980 mm 50-50 s otvory	1		14
30522	Tyč 1920 mm 38-38 s otvory	2		50
30523	Tyč 1960 mm 50-50 s otvory	3		28
30524	Tyč 750 mm Střešní výztuha Řada 8 vertikální	4		7
30525	Tyč 1987 mm Střešní výztuha Řada 8 horizontální	5		14
30673	Tyč 1980 mm 50-50 s 2 otvory	6		14
30526	Rohová spojka se třemi konci 110° 54-42 s kroužky	7		4
30527	Rohová spojka se třemi konci 140° 54-42 s kroužky	8		2
30528	Rohová spojka se čtyřmi konci 140° 54-42 s kroužky	9		5
30529	Rohová spojka se čtyřmi konci 110° 54-42 s kroužky	10		10
30421	T-spojka 54-42	11		4
30420	Křížová spojka 54-42	12		10
30530	Spojka se třemi konci 54-42 do rohu s patkou a kroužky – pravá	13		2
30531	Spojka se třemi konci 54-42 do rohu s patkou a kroužky – levá	14		2
30532	Spojka se třemi konci 54-42 na bok s patkou a kroužky	15		10
30424	Spojka se 2 konci 42-42	16		6

Obsah

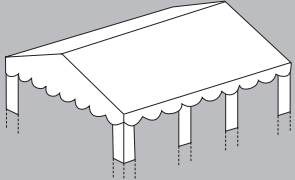
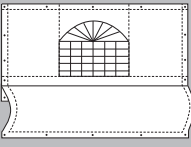
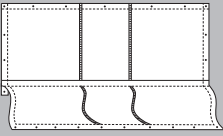
Č. výrobku	Popis	ID číslo		8 × 12 m
30622	Sada napínáků na boční stěny	17		8
30534	Sada napínáků na střechu	18		12
30044	Šroubovací háček	19		4
30046	Hřeb do země 6 × 180 mm	20		20
30047	Hřeb do země 4 × 160 mm	21		36
30430	Pryžová smyčka 14 cm	22		296
30429	Pryžová smyčka 5 cm	23		20
30050	Napínací šňůra 5 m	24		4
30051	Střešní háček	25		14
30382	Imbusový klíč	26		1
30384	Šroub 30 mm	27		28
30404	Šroub 45 mm	28		100
30405	Šroub 65 mm	29		100
30052	Křídlová matice	30		28
30535	Pojistná matice	31		200
30380	Klíč na matice	32		2
	Sřecha	33		1
	Boční stěna	34		12
	Koncová stěna	35		2

Pokyny

1

Vyhledejte rovný poklad, na nějž stan umístíte. Vybalte kartony a zkontrolujte, zda obsahují veškeré zde uvedené díly.

Složte rám střechy: díly 7 až 12 namontujte na tyče (díly 2 a 3) a důkladně je připevněte pomocí šroubů.

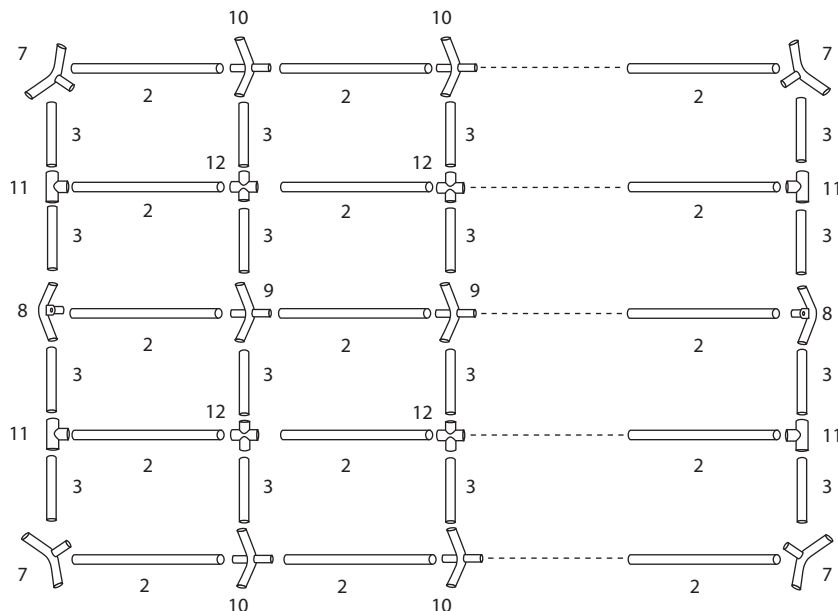

2

Pomocí šroubů (27) a křídlových matic (30) připevněte zesilovací výztuhy (díly 4 a 5).

Střechu zpevněte pomocí napínáků (18), které umístíte vždy napříč dvěma segmenty tak, jak je to uvedeno níže.

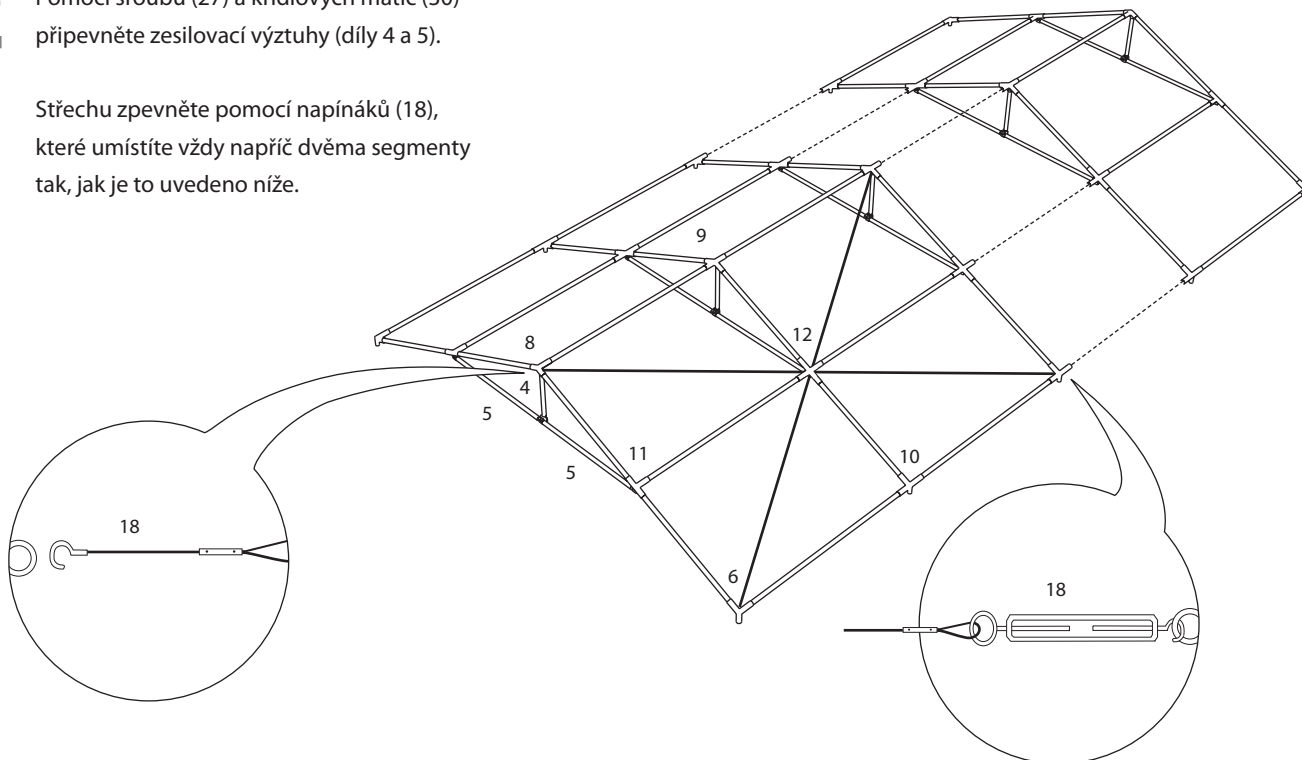

- 3** Nadzdvihněte jednu stranu kostry stanu a nasadte na ni nohy (6). Položte na rám střechu (33) a připevněte ji pryžovými smyčkami (23). Dejte pozor, abyste pryžové smyčky nenapnuli příliš, a neztížili si tak instalaci druhé strany.

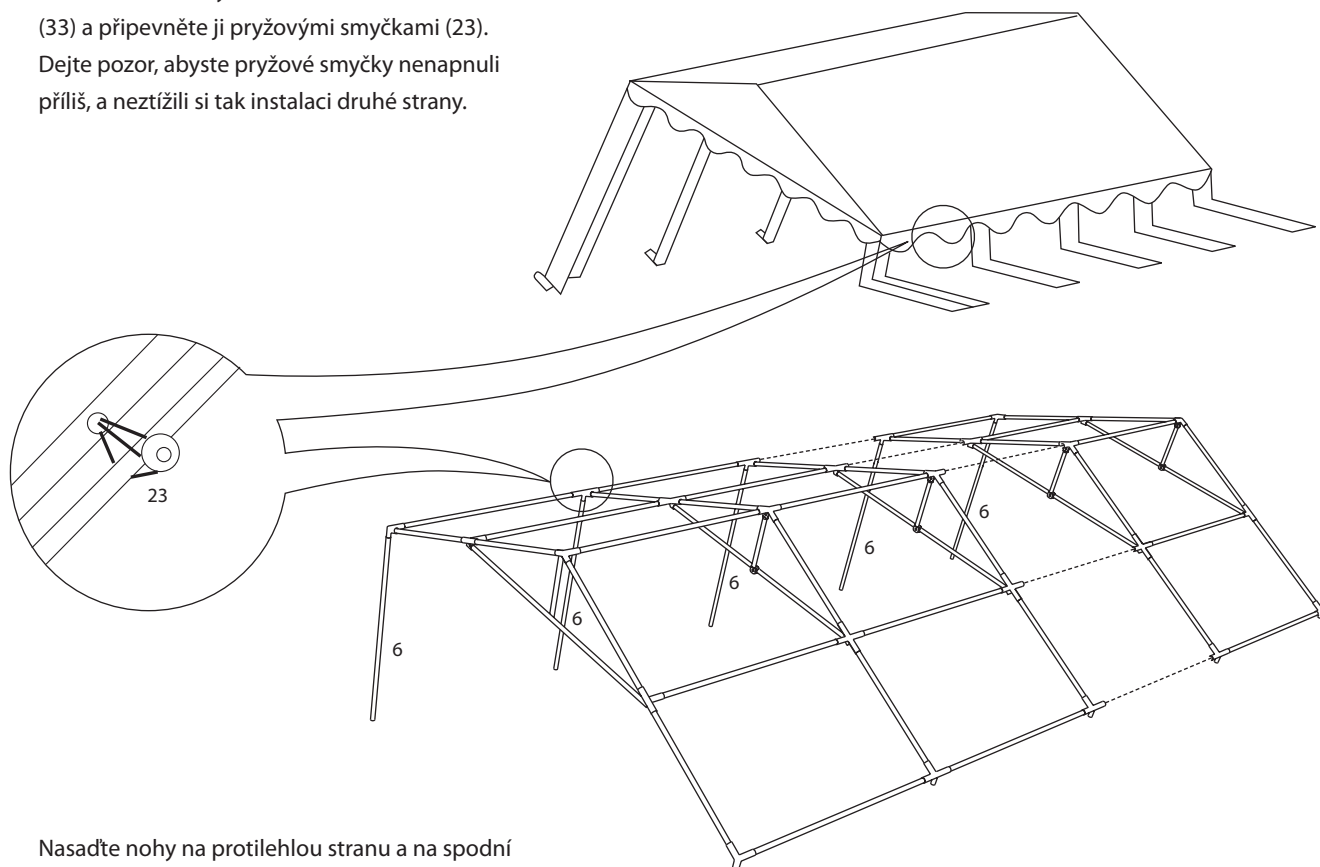

- 4** Nasadte nohy na protilehlou stranu a na spodní konec namontujte patky (12, 13, 14). K připevnění patek k zemi použijte dlouhé hřeby do země (20). Střešní lemy připevněte k tyčím (1) pomocí háčků (25). Konstrukci zpevněte pomocí napínáků (16) stejným způsobem jako střechu. Spodní rám následně doplňte příslušnými tyčemi (2 a 3) a spojkami (15).

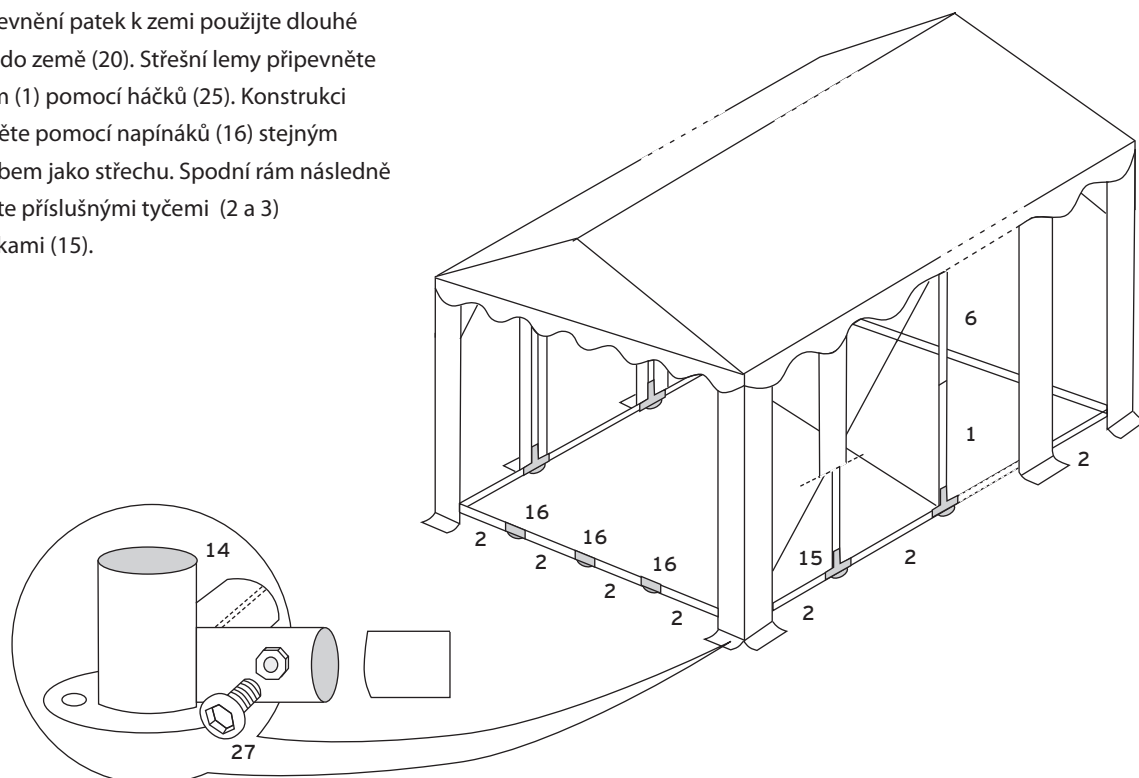

- 5** Rozprostřete boční (34) a koncové stěny (35). Boční stěny připevněte pryžovými smyčkami (22) ke kostře, koncové stěny pak krátkými pryžovými smyčkami (23) přímo ke střeše. Pomocí krátkých hřebů do země (21) připevněte koncové stěny k zemi. Napínací šňůra se natahuje z každého rohu stanu a k zemi se kotví pomocí šroubovacího háčku (19).

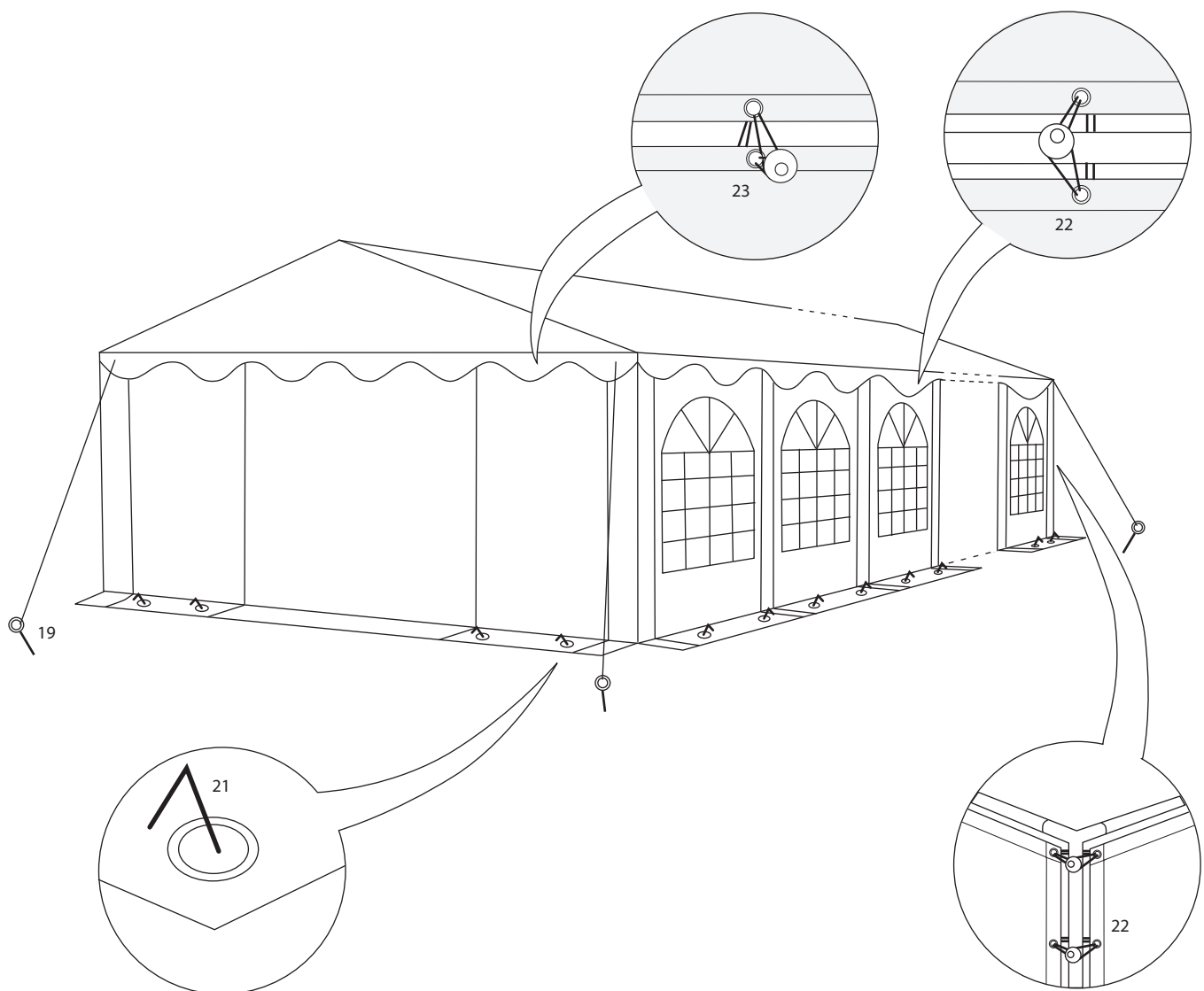

Čištění a údržba















Střechu a boční části lze omývat mýdlovým roztokem. Plíseň a skvrny vzniklé vlhkostí odstraňujte jemným chlorovým roztokem. Dodržujte pokyny výrobce a chlorový roztok nejprve vyzkoušejte na místě, které není vidět. Tímto způsobem se ujistěte, zda nedochází ke změně zbarvení.

Pozor! Party stan se nesmí skládat ani balit ve vlhkém stavu. Nechejte jej před tím zcela vyschnout.







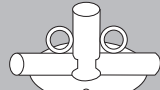
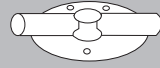





Varování

1. Se stanem manipulujte opatrně, předejdete tak jeho poškození.
2. Na soutyčí nepoužívejte nadměrnou sílu, jinak by mohlo dojít k jeho poškození.
3. Stany jsou určeny k dočasnému pobytu a neměly by se sestavovat za nepříznivých povětrnostních podmínek.
4. Vždy udržujte vhodný odstup od hadic, plynového a elektrického vedení, aby nedošlo k jejich poškození.
5. Při používání vhodných topných těles (informace získáte například ve specializovaných obchodech) dodržujte minimální odstup 1,2 metru od plachty. V žádném případě byste neměli používat otevřený oheň a topná tělesa, která otevřený oheň využívají, například topné hříby, terasové sálače, plynová topidla atd.
6. Sestavující osoba odpovídá za přiměřené ukotvení, a tím pádem za bezpečnost stanu.

Contenido

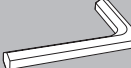
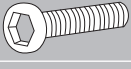
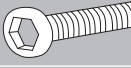
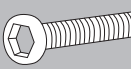
Nº de art.	Descripción	Nº de ident.		8x12m
30672	Barra 1.980 mm 50-50 con agujeros	1		14
30522	Barra 1.920 mm 38-38 con agujeros	2		50
30523	Barra 1.960 mm 50-50 con agujeros	3		28
30524	Barra 750 mm Travesaño del techo Serie 8 vertical	4		7
30525	Barra 1.987 mm Travesaño del techo Serie 8 horizontal	5		14
30673	Barra 1.980 mm 50-50 con 2 agujeros	6		14
30526	Conector angular triple 110° 54-42 con aros	7		4
30527	Conector angular triple 140° 54-42 con aros	8		2
30528	Conector angular cuádruple 140° 54-42 con aros	9		5
30529	Conector angular cuádruple 110° 54-42 con aros	10		10
30421	Pieza en T 54-42	11		4
30420	Pieza en cruz 54-42h	12		10
30530	Conector triple - pie para las esquinas 54-42 con aro, a la derecha	13		2
30531	Conector triple - pie para las esquinas 54-42 con aro, a la izquierda	14		2
30532	Conector triple - pie para las paredes laterales 54-42 con aros	15		10
30424	Conector doble - pie 42-42	16		6

Contenido

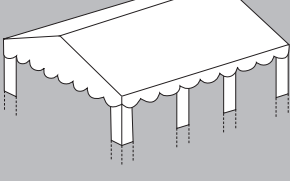
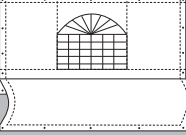
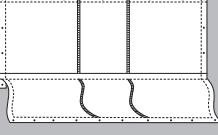
Nº de art.	Descripción	Nº de ident.		8x12m
30622	Tensor para los laterales	17		8
30534	Tensor para el techo	18		12
30044	Gancho roscado	19		4
30046	Clavo de tierra 6x180 mm	20		20
30047	Clavo de tierra 4x160 mm	21		36
30430	Pasador de goma 14 cm	22		296
30429	Pasador de goma 5 cm	23		20
30050	Cuerda tensora 5 m	24		4
30051	Gancho de techo	25		14
30382	Llave Allen	26		1
30384	Tornillo 30 mm	27		28
30404	Tornillo 45 mm	28		100
30405	Tornillo 65 mm	29		100
30052	Tuerca de mariposa	30		28
30535	Tuerca	31		200
30380	Llave de boca	32		2
	Techo	33		1
	Pared lateral	34		12
	Pared final	35		2

Instrucciones

1

Busque una superficie llana para instalar la carpa. Abra el embalaje y compruebe si están todas las piezas que aquí se enumeran.

Ensamble el armazón del techo montando las piezas de 7 a 12 en las barras (piezas 2 y 3) y apriete los tornillos para fijarlas.

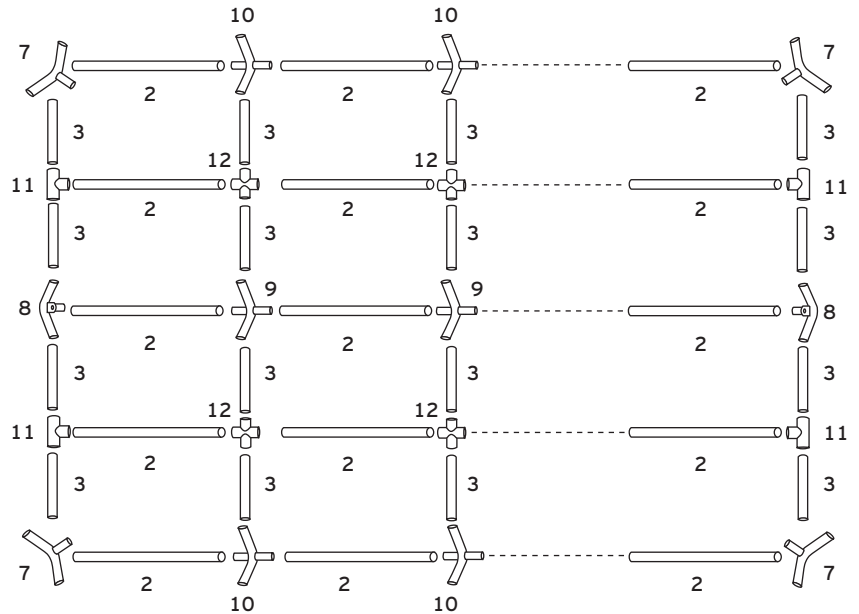

2

Estabilice el techo con ayuda del tensor (18). La sujeción se realiza en diagonal mediante dos secciones, tal y como se muestra en el dibujo.

Fije los travesaños de refuerzo (piezas 4 y 5) con tornillos (27) y tuercas de mariposa (30).

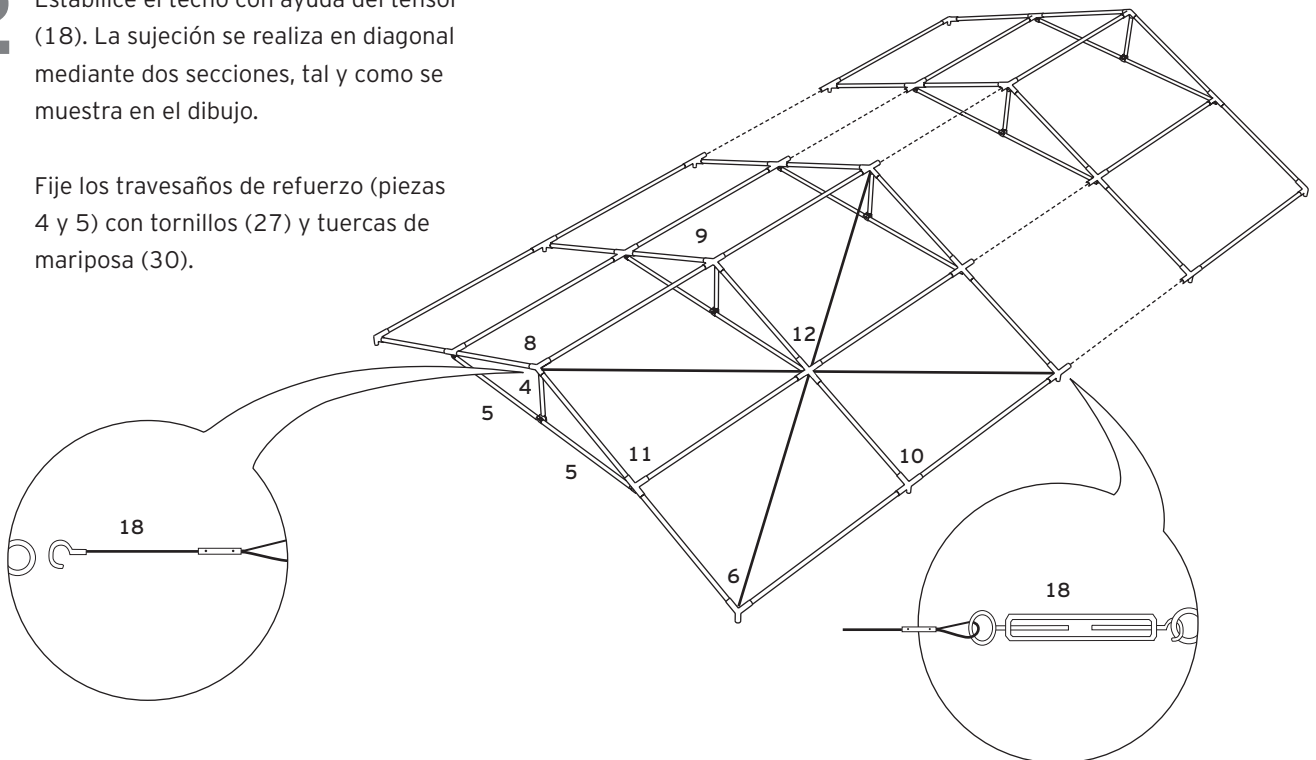

3 Levante una parte de la estructura de la carpa y coloque las patas (6). Coloque el techo (33) sobre el armazón y sujételo con los pasadores de goma (23). Procure que los pasadores de goma no queden muy tirantes para no dificultar la colocación de la otra parte.

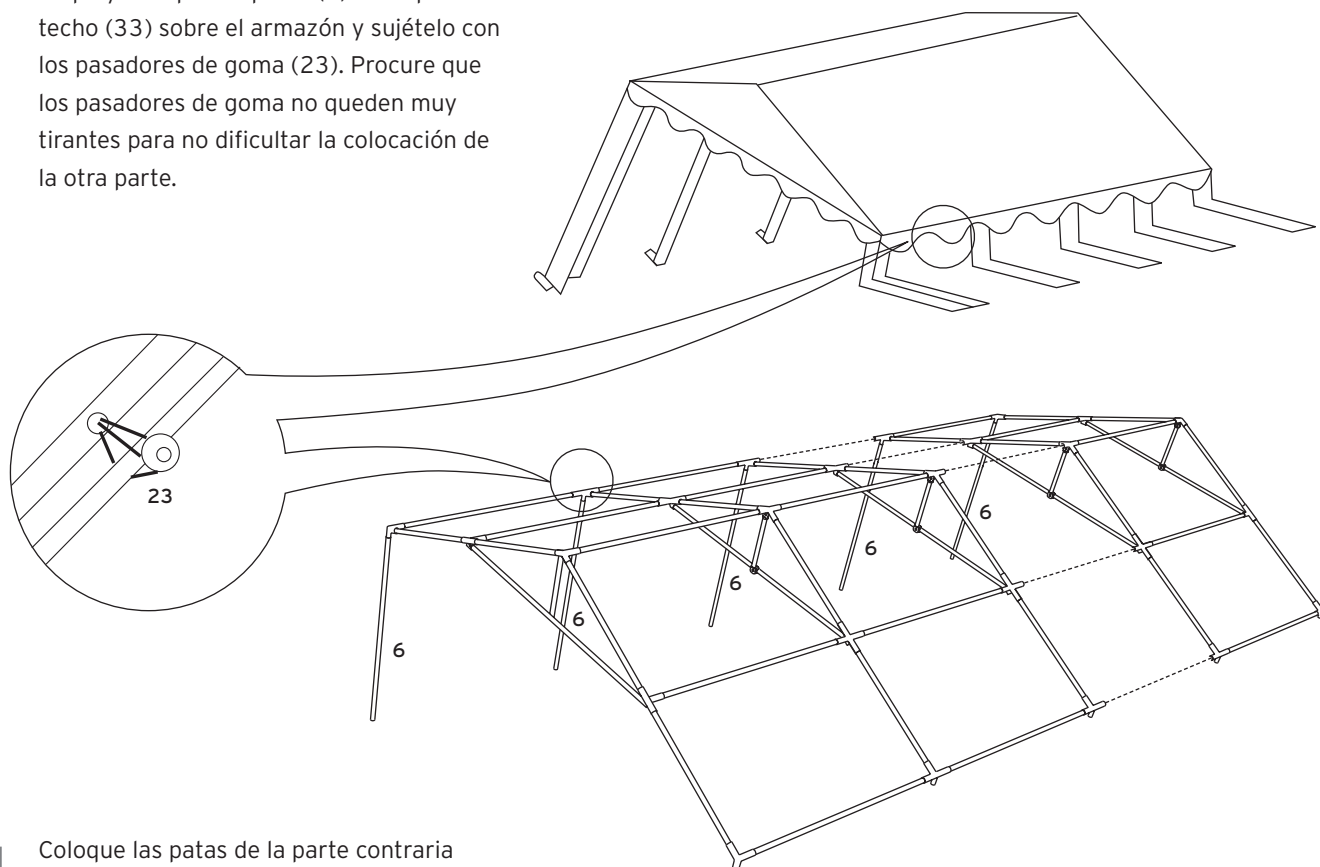

4 Coloque las patas de la parte contraria y monte los pies (12, 13, 14) en los extremos inferiores. Utilice los clavos de tierra largos (20) para sujetar los pies al suelo. La cubierta del techo se fija a las barras (1) con ganchos (25). Refuerce el armazón lateral con el tensor (16). A continuación, complete la estructura de la base con las barras (2 y 3) y conectores (15) correspondientes.

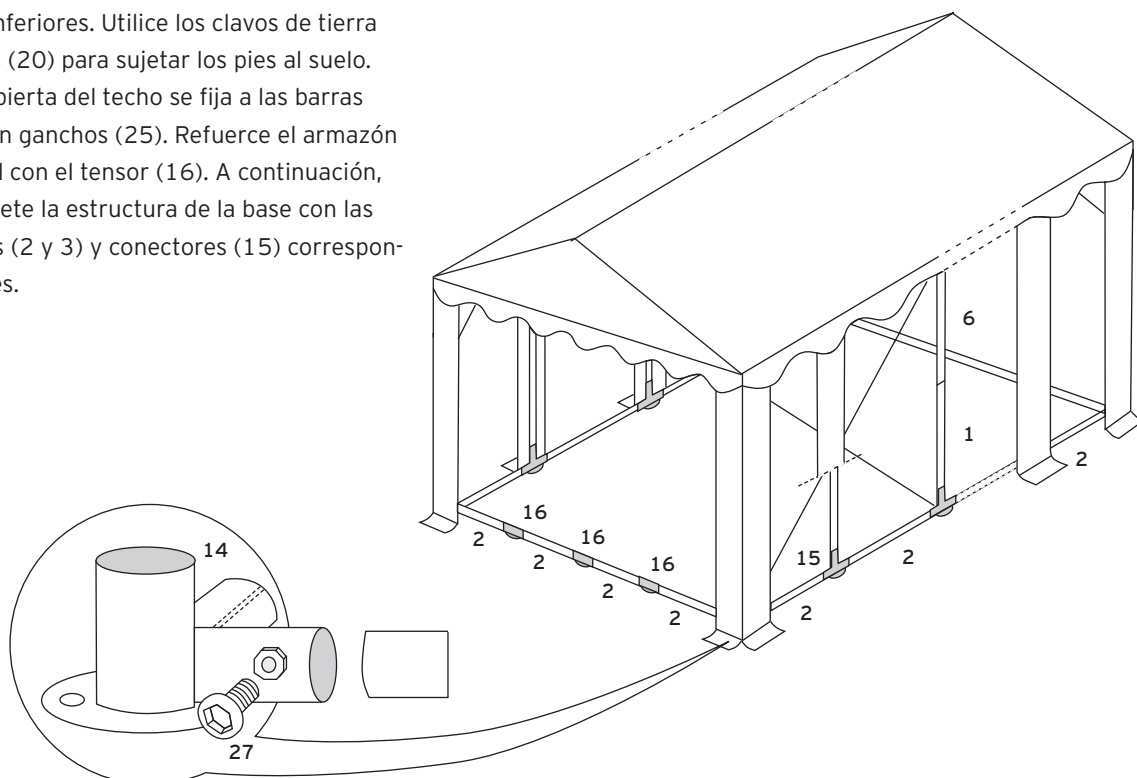

- 5** Extienda las paredes laterales (34) y finales (35) y sujete las paredes laterales con los pasadores de goma (22) al armazón. Las paredes finales se fijan directamente al techo con los pasadores de goma cortos (23). Fije las paredes finales al suelo con los clavos de tierra cortos (21). La cuerda tensora se extiende desde cada esquina de la carpa y se sujeta al suelo con el gancho roscado (19).

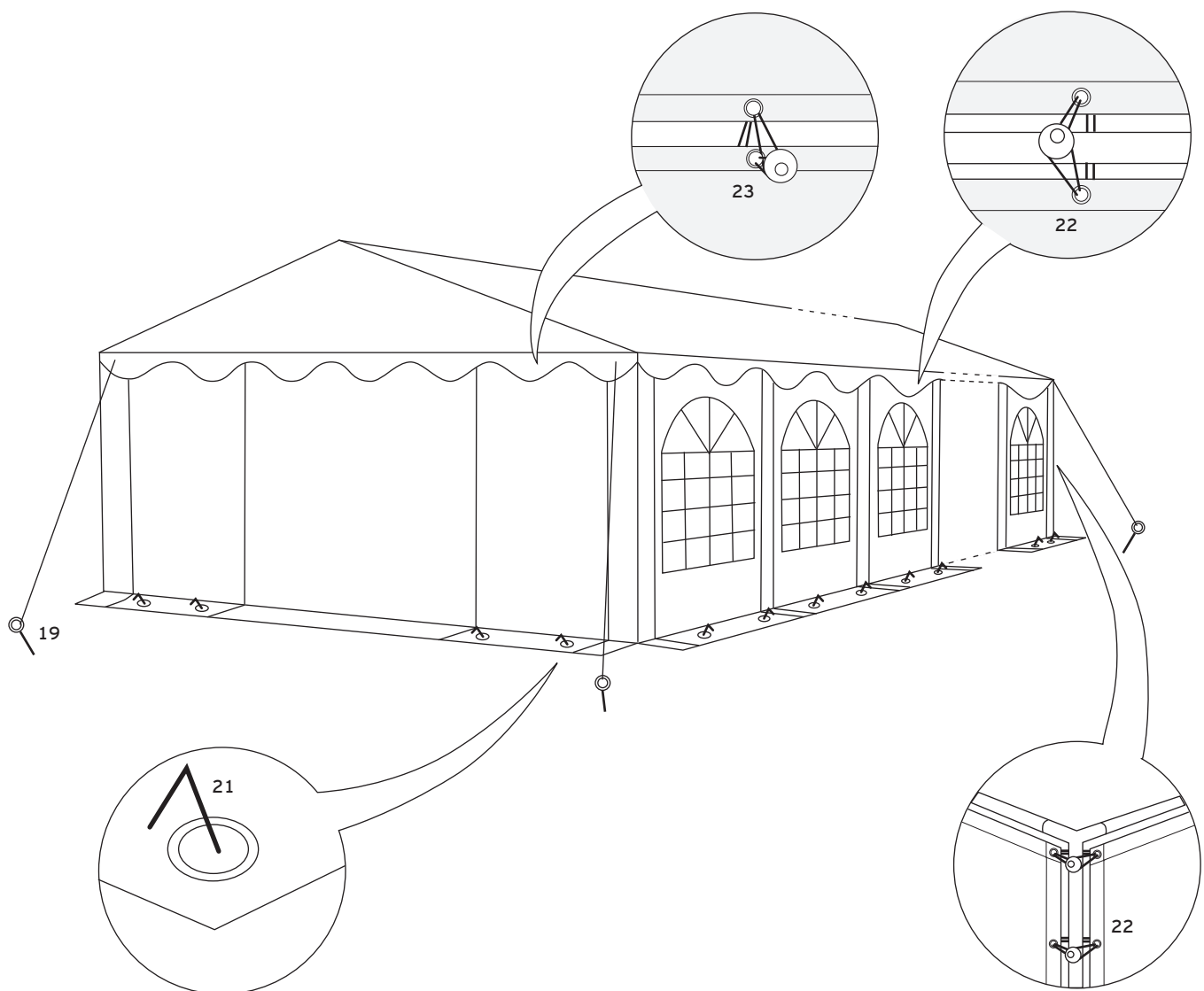

Limpieza y mantenimiento

El techo y las piezas laterales pueden lavarse con lejía jabonosa. Limpie el moho y las manchas de humedad con una solución suave de cloro. Siga las instrucciones del fabricante y pruebe la solución de cloro en una zona que no se vea para asegurarse de que no se produzcan decoloraciones.

¡Atención! No pliegue la carpa ni la embale si está húmeda, deje que antes se seque por completo.

Advertencias

1. Procure manejar la carpa con cuidado para evitar daños.
2. No ejerza demasiada fuerza sobre las barras, ya que podrían dañarse.
3. Las carpas han sido diseñadas como alojamiento temporal y deben desmontarse en caso de condiciones atmosféricas desfavorables.
4. Procure que siempre haya una distancia adecuada con tubos y conducciones de gas o electricidad para evitar que se dañen.
5. Si se utilizan calefactores adecuados (infórmese en un comercio especializado), se ha de mantener una distancia de al menos 1,2 m con el material de las lonas. No haga nunca fuegos al aire libre ni utilice calefactores con llamas libres, como estufas para terrazas, calentadores de gas, etc.
6. La persona que instale la carpa es responsable de realizar un anclaje adecuado de la misma para garantizar su seguridad.