

5 m series

★ ★ ★ ★
PREMIUM

DE Gebrauchsanweisung PVC-Zelt

GB Assembly instruction PVC-Tent

PL Instrukcja obsługi PVC-Namioty

NL Gebruiksaanwijzing PVC-Tent







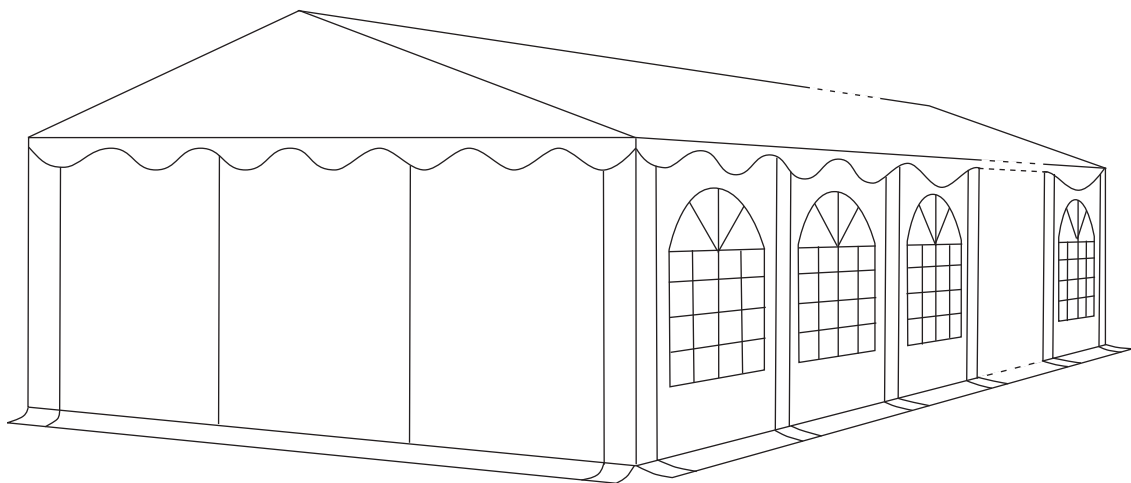



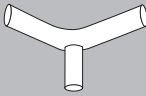
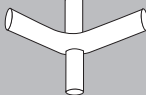

FR Mode d'emploi Tente PVC

CZ Instrukce PVC Stan

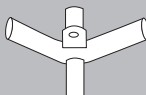
ES Manual de instrucciones Carpa de PVC

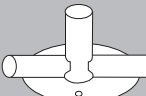
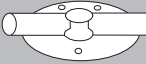

Inhalt

Artikel Nr.	Beschreibung	ID Nummer		5x6m	5x8m	5x10m	5x12m
30053	Stange 1218 mm 38-38	1		16	20	24	28
30055	Stange 1940 mm 38-38	2		21	28	35	42
30056	Stange 1920 mm 38-38 mit Löchern	3		8	10	12	14
30058	Stange 1275 mm Dachstrebe 5-Serie horizontal	4		8	10	12	14
30060	Stange 470 mm Dachstrebe 5-Serie vertikal	5		4	5	6	7
30076	3er Eckverbinder 110°	6		4	4	4	4
30077	4er Eckverbinder 110°	7		4	6	8	10
30071	3er Eckverbinder 140°	8		2	2	2	2
30079	4er Eckverbinder 140°	9		2	3	4	5
30070	Kreuzstück	10		4	6	8	10
30069	T-Stück	11		4	4	4	4
30066	3fach Eckverbinder - Fuß	12		4	4	4	4
30067	3fach Verbinder - Fuß	13		4	6	8	10
30068	2fach Verbinder - Fuß	14		4	4	4	4
30432	Stange 1600 mm 38-38	15		6	6	6	6
30044	Schraubhaken	16		4	4	4	4

Gebrauchsanweisung

1

Suchen Sie einen ebenen Untergrund für das Zelt. Packen Sie die Kartons aus und sehen Sie nach, ob auch alle hier aufgelisteten Teile vorhanden sind.

Setzen Sie den Rahmen für das Dach zusammen indem Sie die Teile 6 bis 11 an die Stangen (Teile 1 u. 2) montieren und zur Fixierung mit den Schrauben fest anziehen.

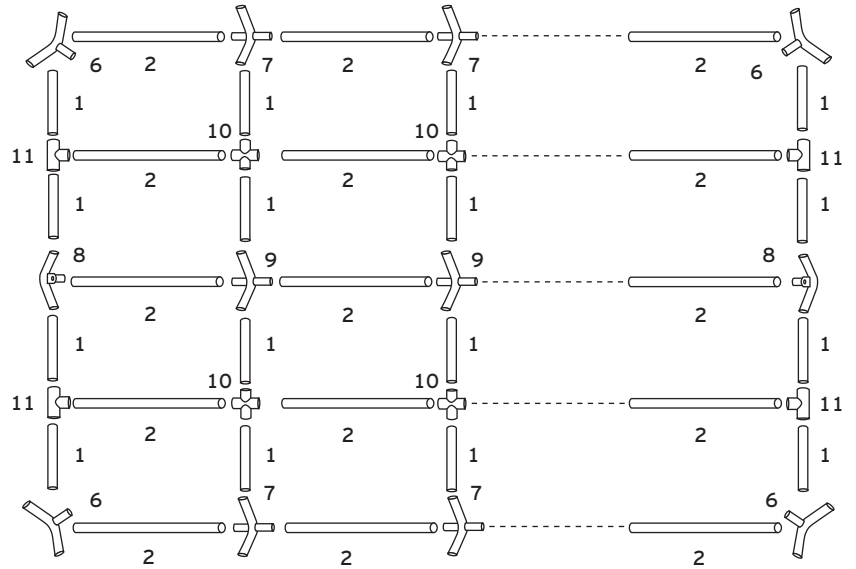

2

Befestigen Sie die Verstärkungsstreben (Teile 4 u.5) mit Schrauben (20) und Flügelmuttern (21).

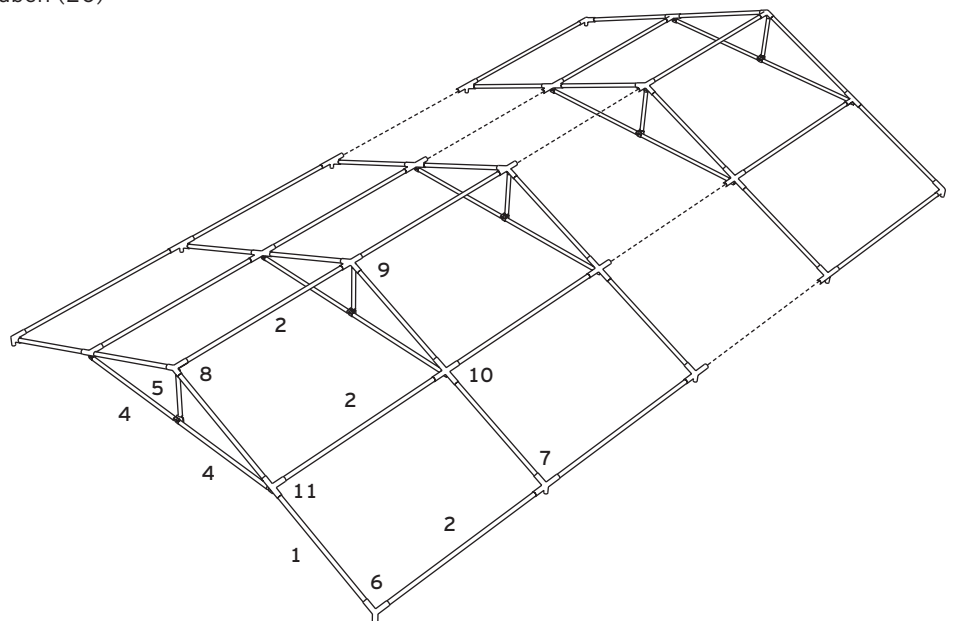

- 3** Heben Sie eine Seite des Zeltgerüsts an und setzen Sie die Beine (3) ein. Setzen Sie das Dach (27) auf den Rahmen und befestigen Sie es mit den Gummischlaufen (24). Achten Sie darauf, nicht zu viel Spannung auf die Gummischlaufen zu geben, um das Anbringen der anderen Seite nicht zu erschweren.

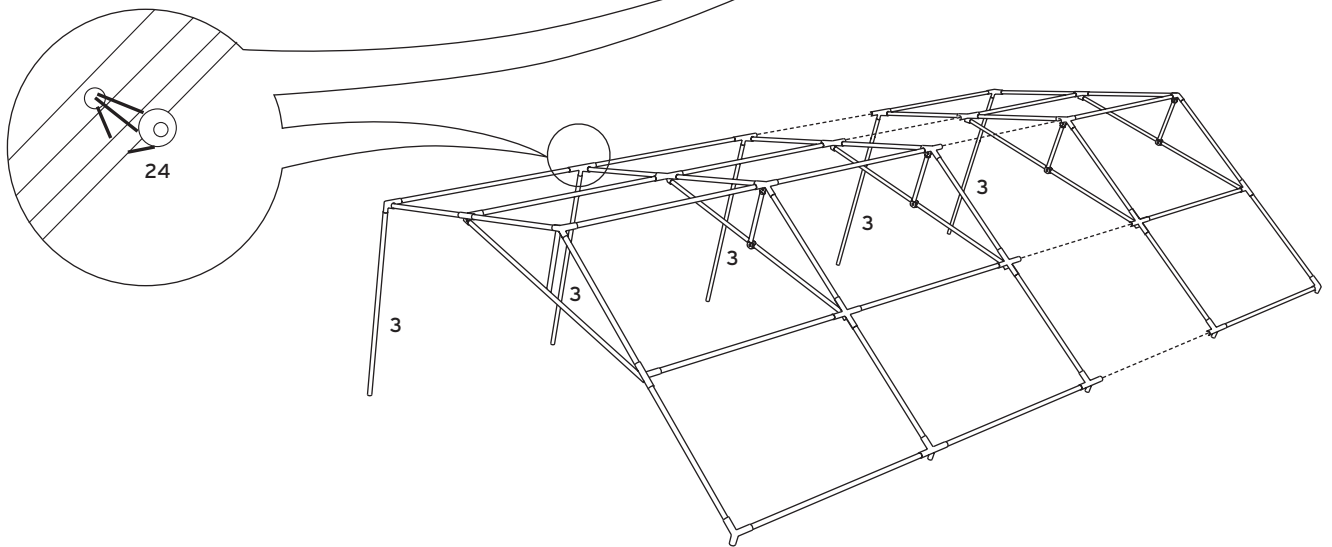
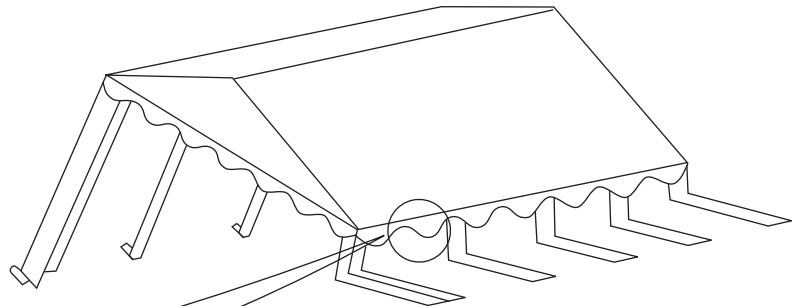

- 4** Stecken Sie die Beine auf der gegenüberliegenden Seite ein und montieren Sie an den unteren Enden die Füße (12, 13). Benutzen Sie die langen Erdnägel (17) um die Füße am Boden zu befestigen. Die Dachschaals werden mit Haken (26) an den Stangen (3) befestigt. Anschließend vervollständigen Sie den Bodenrahmen mit den entsprechenden Stangen (2, 15) /Verbinder (14).

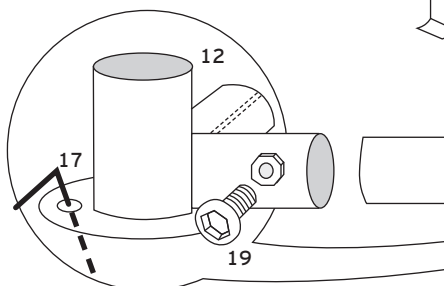
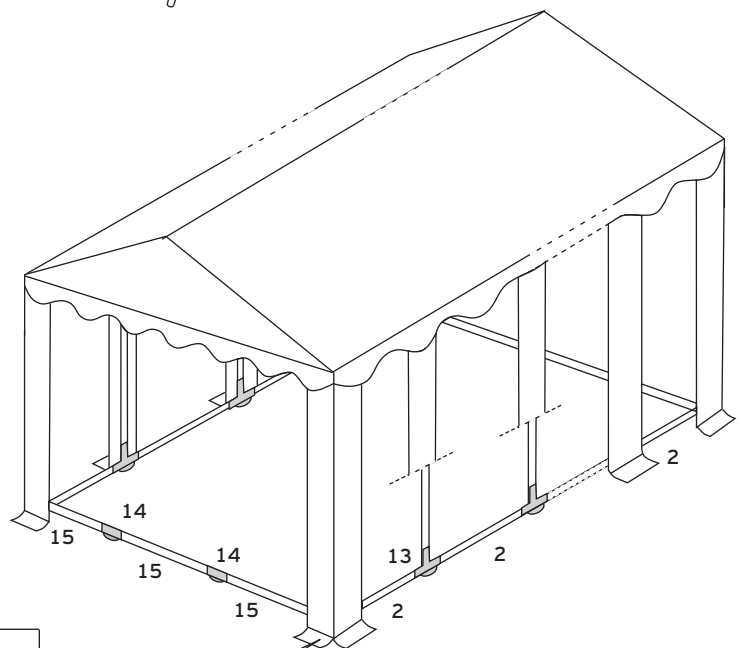

- 5** Breiten Sie die Seitenwände (28) und Endwände (29) aus und befestigen Sie die Seitenwände mit den Gummischlaufen (23) am Gerüst und die Endwände mit den kurzen Gummischlaufen (24) direkt am Dach. Mit den kurzen Erdnägeln (18) befestigen Sie die Endwände am Boden. Die Spannleine läuft von jeder Ecke des Zeltes und wird mit dem Schraubhaken (16) am Boden verspannt.

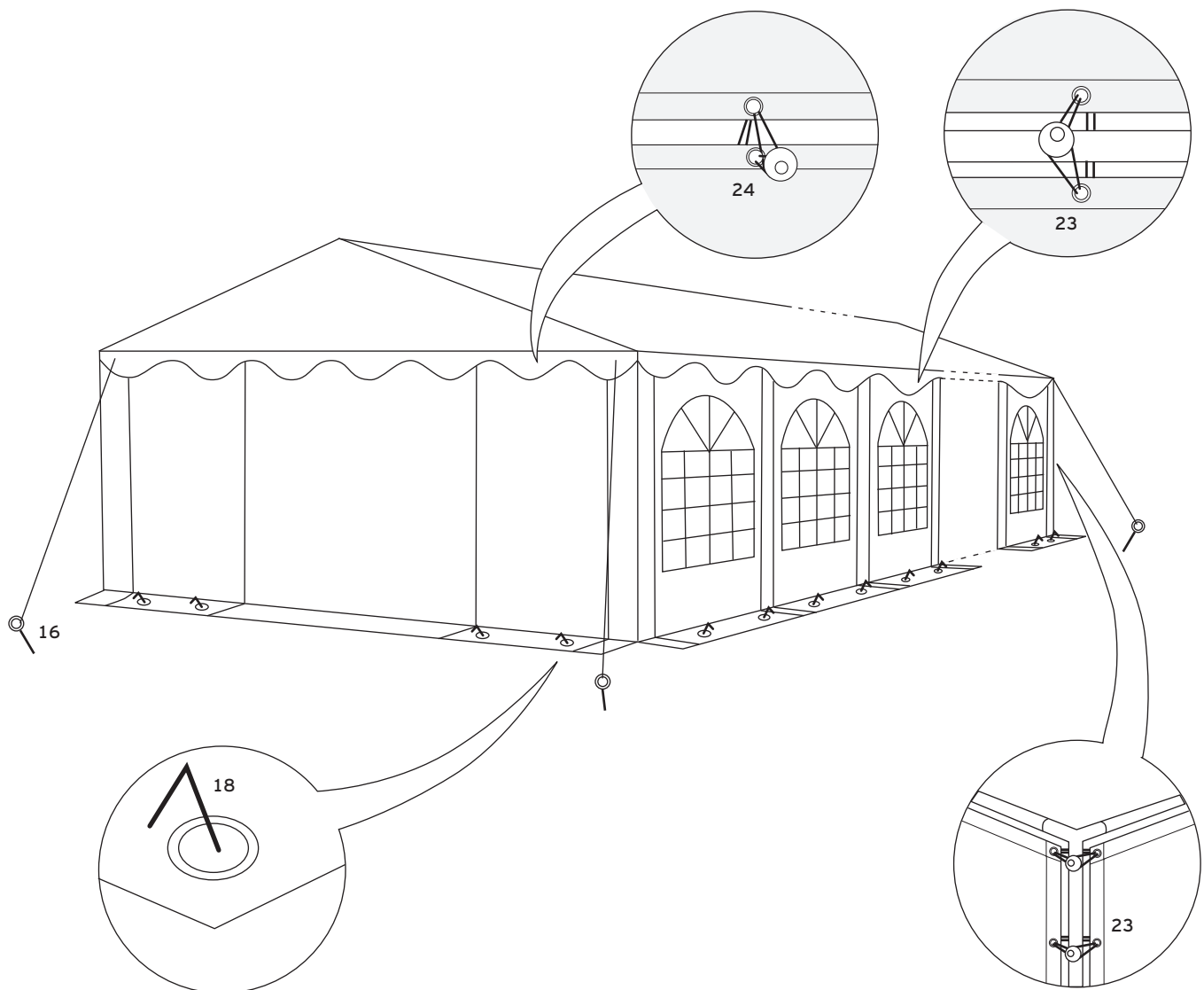

Reinigung und Wartung











Dach und Seitenteile lassen sich mit Seifenlauge abwaschen. Schimmel und Stockflecken entfernen Sie mit einer milden Chlorlösung. Befolgen Sie die Anweisungen des Herstellers und testen Sie die Chlorlösung an einer nicht sichtbaren Stelle, um sicherzugehen, dass keine Verfärbungen auftreten.

Achtung! Das Partyzelt darf nicht im nassen Zustand zusammengelegt und verpackt werden. Lassen Sie es vorher vollständig trocknen.

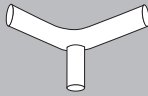
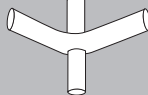

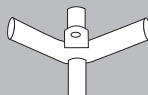

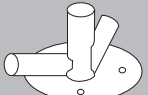
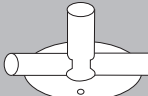
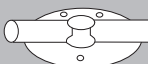



Warnung

1. Bitte achten Sie darauf, das Zelt vorsichtig zu behandeln, um Defekte zu vermeiden.
2. Das Gestänge nicht zu kräftig behandeln, da dies ansonsten Beschädigt werden könnte.
3. Zelte sind als temporäre Unterkunft gedacht und sollten bei widrigen Witterungsverhältnissen abgebaut werden.
4. Bitte wählen Sie immer einen geeigneten Abstand zu Schläuchen, Gas- oder Elektroleitungen, um diese nicht zu beschädigen.
5. Beim Einsatz geeigneter Heizgeräte (z. B. Auskunft im Fachhandel) ist ein Abstand von mindestens 1,2 m zu jeglichem Planenmaterial zu beachten. Offenes Feuer sowie Heizgeräte mit offenen Flammen wie Heizpilze, Terrassenstrahler, Gasheizer etc. sollten auf keinen Fall verwendet werden.
6. Der Aufbauer ist verantwortlich für die angemessene Verankerung und damit für die Sicherheit des Zeltes.

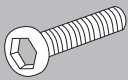
Contents

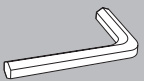
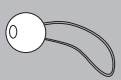
Part no.	Description	ID no.		5x6m	5x8m	5x10m	5x12m
30053	pipe 1218 mm 38-38	1		16	20	24	28
30055	pipe 1940 mm 38-38	2		21	28	35	42
30056	pipe 1920 mm 38-38 with hole	3		8	10	12	14
30058	pipe 1275 mm roof brace 5-Serie horizontal	4		8	10	12	14
30060	pipe 470 mm roof brace 5-Serie vertical	5		4	5	6	7
30076	connector three way 110°	6		4	4	4	4
30077	connector four way 110°	7		4	6	8	10
30071	connector three way 140°	8		2	2	2	2
30079	connector four way 140°	9		2	3	4	5
30070	cross piece	10		4	6	8	10
30069	T-piece	11		4	4	4	4
30066	connector three way - leg	12		4	4	4	4
30067	connector three way - leg	13		4	6	8	10
30068	connector two way - leg	14		4	4	4	4
30432	pipe 1600 mm 38-38	15		6	6	6	6
30044	screw hook	16		4	4	4	4

Contents

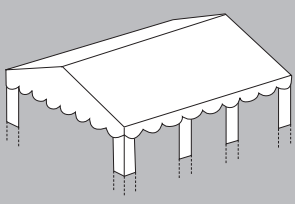
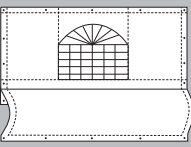
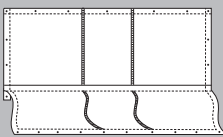
Part no.	Description	ID no.		5x6m	5x8m	5x10m	5x12m
30046	ground peg 6x180 mm	17		8	10	12	14
30047	ground peg 4x160 mm	18		36	42	48	54
30383	screw 10 mm	19		102	128	154	180
30384	screw 30 mm	20		16	20	24	28
30052	wing nut	21		16	20	24	28
30382	hex key	22		1	1	1	1
30430	bungee 14 cm type 1	23		123	147	171	195
30429	bungee 5 cm type 1	24		22	22	22	22
30050	guy rope 3 m	25		4	4	4	4
30051	roof hook	26		8	10	12	14
	roof	27		1	1	1	1
	side wall	28		6	8	10	12
	end wall	29		2	2	2	2

Instructions

1

Select a flat surface for the tent. Unpack the boxes and check if all listed parts are included.

Assemble the roof frame by mounting parts 6 to 11 on the pipes (parts 1 and 2). Use the screws to firmly attach the parts.

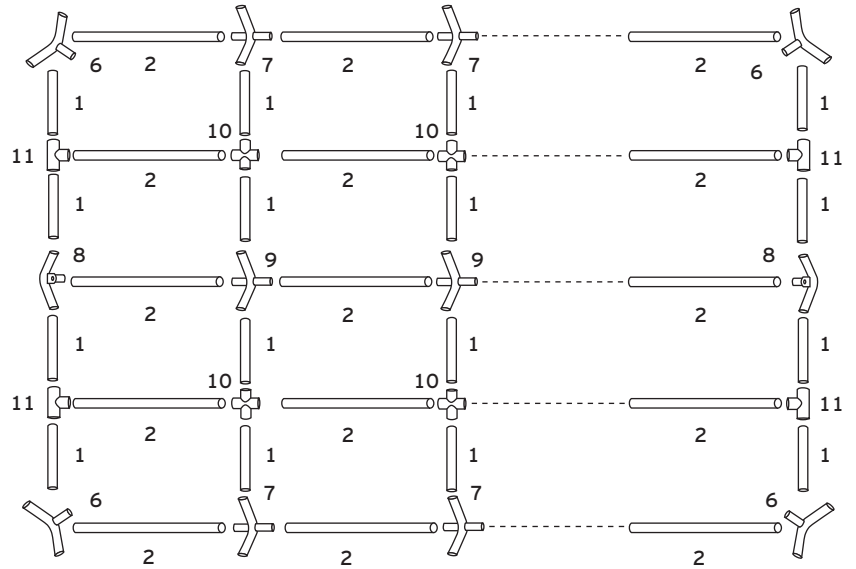

2

Attach the reinforcement braces (parts 4 and 5) using screws (20) and wing nuts (21).

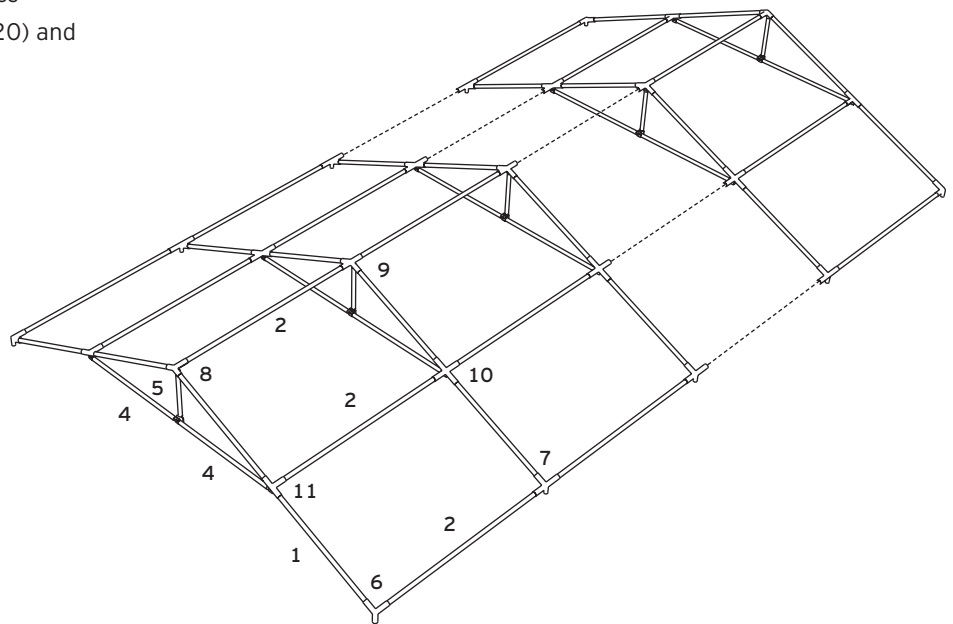

3

Lift one side of the tent frame and attach the legs (3). Place the roof (27) onto the frame and use the bungees (24) to fasten it. Be sure not to put too much tension on the bungees in order not to make attaching the other side more difficult.

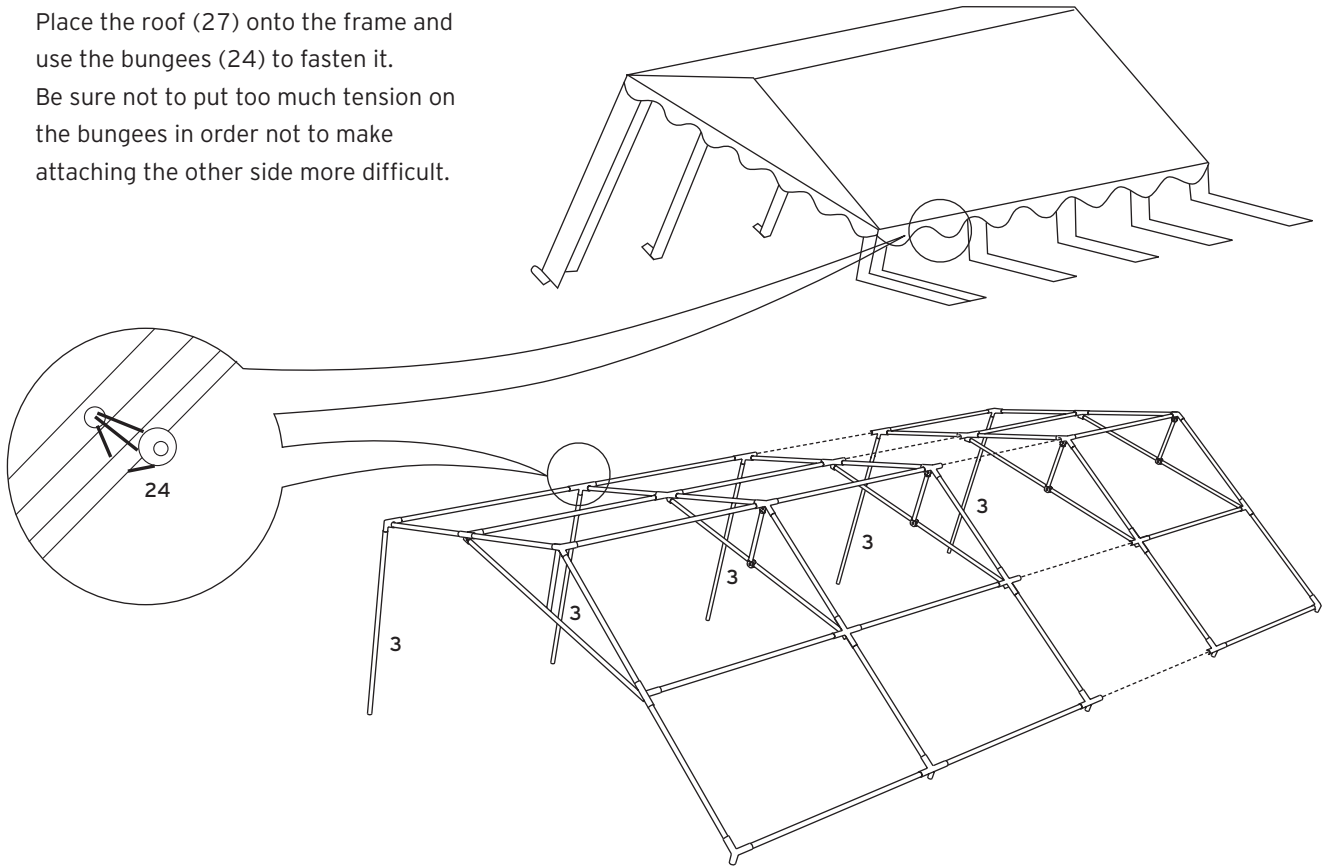

4

Attach the legs on the other side and install the feet (12, 13) at the bottom. Use the long ground pegs (17) to fasten the legs to the ground. Attach the side covers to the pipes (3) using hooks (26). Complete the bottom frame with the required pipes (2, 15) and connector (14).

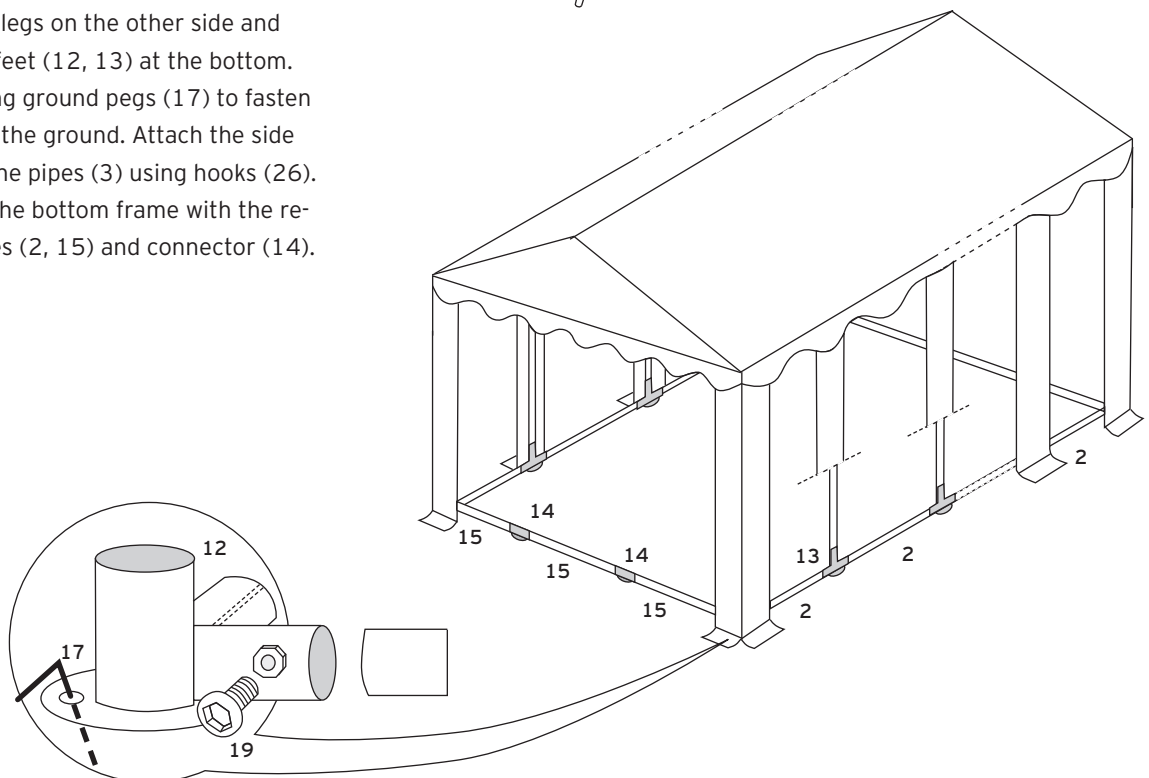

- 5** Extend the side walls (28) and the end walls (29) and attach the side walls to the frame using the bungees (23). Attach the end walls directly to the roof using the short bungees (24). Use the short ground pegs (18) to fasten the end walls to the ground. The guy rope runs from every corner of the tent and is braced using the screw hooks (16).

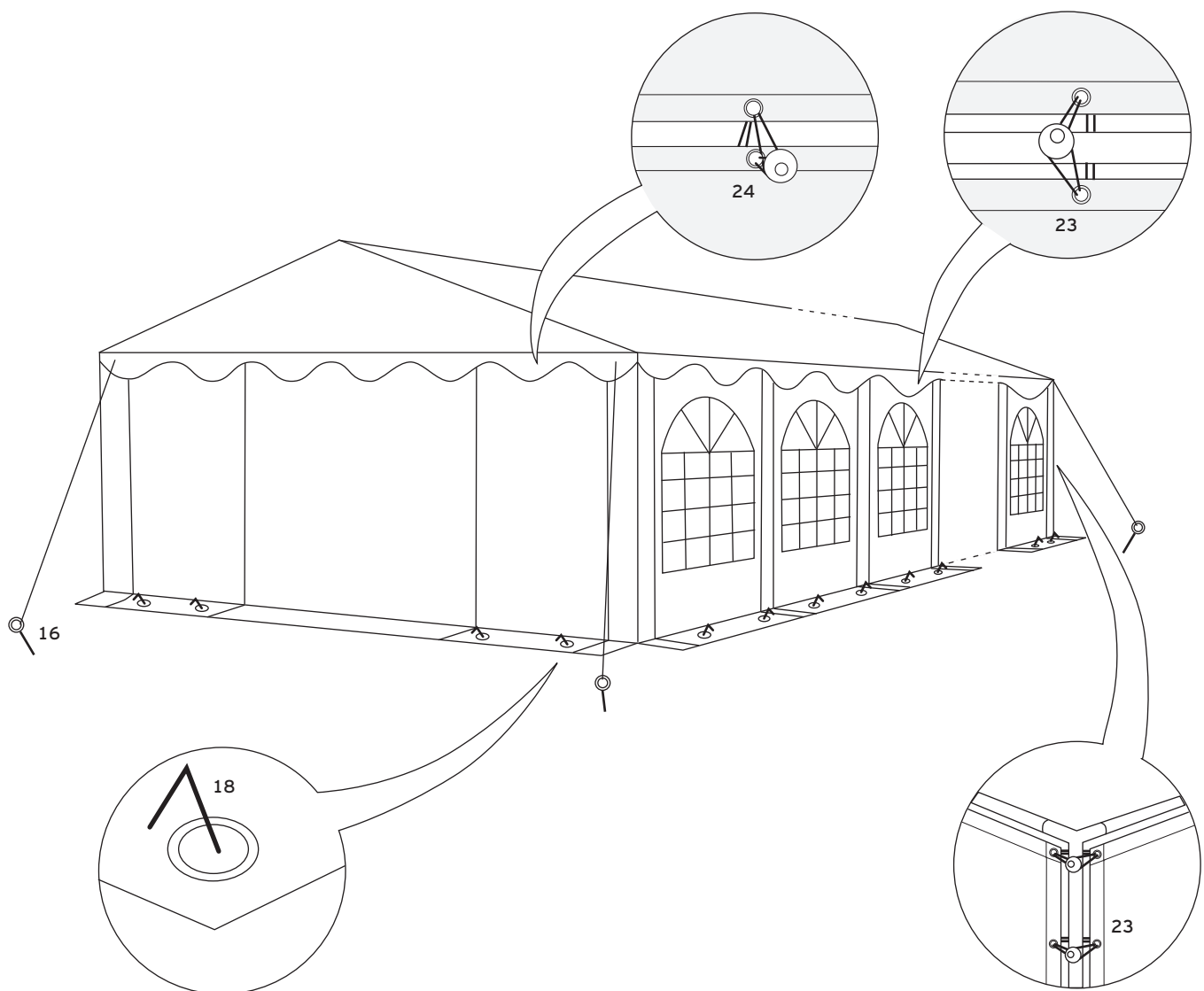

Cleaning and maintenance













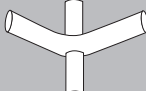

Wash off the roof and the side parts with soapy water. Mould and mould stains can be removed using a mild chlorine solution. Observe the instructions provided by the manufacturer and test the chlorine solution on a hidden spot to make sure that there is no discolouration.

Caution! The party tent must not be collapsed and packed up when it is wet. First, allow it to dry completely.

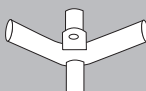



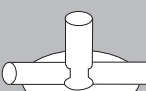
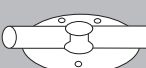



Caution

1. Always handle the tent with care to avoid damage.
2. Do not apply too much pressure to the frame parts to avoid damage.
3. Tents are intended for temporary accommodation and should be taken down in adverse weather conditions.
4. Always be sure to keep sufficient distance to hoses as well as gas and power lines in order to avoid possible damage.
5. When using suitable heaters (available e.g. in specialist shops), keep a minimum distance of 1.2 m to tarp material. Open fire and heaters with open flames such as patio heaters, umbrella heaters, gas heaters etc. should not be used in any case.
6. The person setting up the tent is responsible for adequately securing it to ensure its safety.

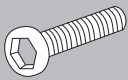
Zawartość

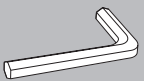
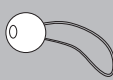
Nr kat.	Opis	Nr ID		5 x 6 m	5 x 8 m	5 x 10 m	5 x 12 m
30053	Drażek 1218 mm 38-38	1		16	20	24	28
30055	Drażek 1940 mm 38-38	2		21	28	35	42
30056	Drażek 1920 mm 38-38 z otworami	3		8	10	12	14
30058	Drażek 1275 mm Wspornik dachu seria 5, poziomy	4		8	10	12	14
30060	Drażek 470 mm Wspornik dachu seria 5, pionowy	5		4	5	6	7
30076	Łącznik narożny potrójny 110°	6		4	4	4	4
30077	Łącznik narożny poczwórny 110°	7		4	6	8	10
30071	Łącznik narożny potrójny 140°	8		2	2	2	2
30079	Łącznik narożny poczwórny 140°	9		2	3	4	5
30070	Czwórnik	10		4	6	8	10
30069	Trójnik	11		4	4	4	4
30066	Łącznik narożny potrójny – stopka	12		4	4	4	4
30067	Łącznik potrójny – stopka	13		4	6	8	10
30068	Łącznik podwójny – stopka	14		4	4	4	4
30432	Drażek 1600 mm 38-38	15		6	6	6	6
30044	Hak wkręcany	16		4	4	4	4

Zawartość

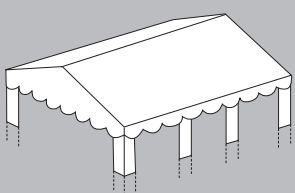
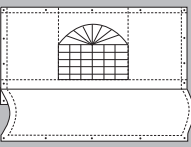
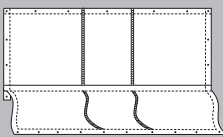
Nr kat.	Opis	Nr ID		5 x 6 m	5 x 8 m	5 x 10 m	5 x 12 m
30046	Szpilka 6x180 mm	17		8	10	12	14
30047	Szpilka 4 x 160 mm	18		36	42	48	54
30383	Śruba 10 mm	19		102	128	154	180
30384	Śruba 30 mm	20		16	20	24	28
30052	Nakrętka skrzydełkowa	21		16	20	24	28
30382	Klucz imbusowy	22		1	1	1	1
30430	Pętelka gumowa 14 cm typ 1	23		123	147	171	195
30429	Pętelka gumowa 5 cm typ 1	24		22	22	22	22
30050	Linka naciągowa 3 m	25		4	4	4	4
30051	Hak dachu	26		8	10	12	14
	dachu	27		1	1	1	1
	Ściana boczna	28		6	8	10	12
	Ściana szczytowa	29		2	2	2	2

Instrukcja montażu

1 Znajdź płaską powierzchnię do rozstawienia namiotu. Rozpakuj kartony i sprawdź, czy zawierają wszystkie wymienione tutaj elementy.

Zmontuj ramę dachu. W tym celu połącz elementy 6 do 11 z drążkami (elementy 1 i 2) i dokręć je mocno śrubami.

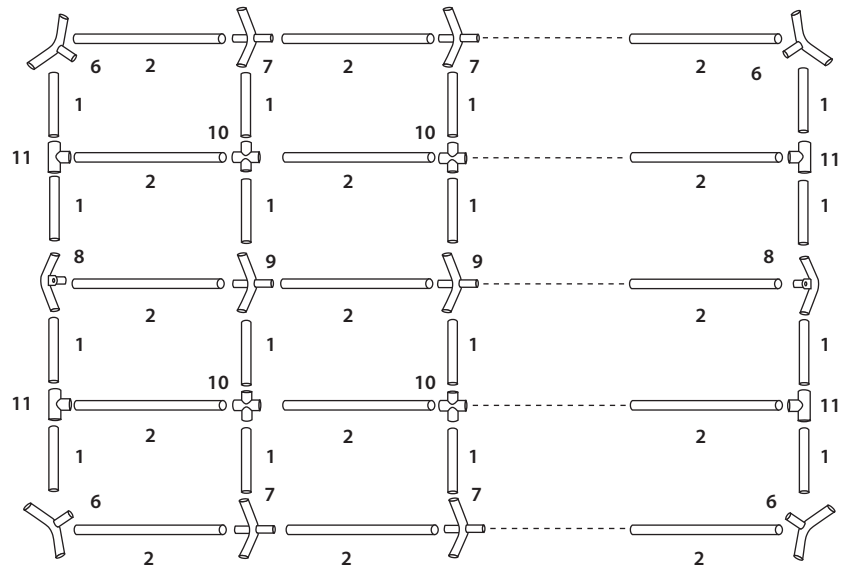

2 Za pomocą śrub (20) i nakrętek skrzydełkowych (21) zamocuj wsporniki wzmacniające (elementy 4 i 5).

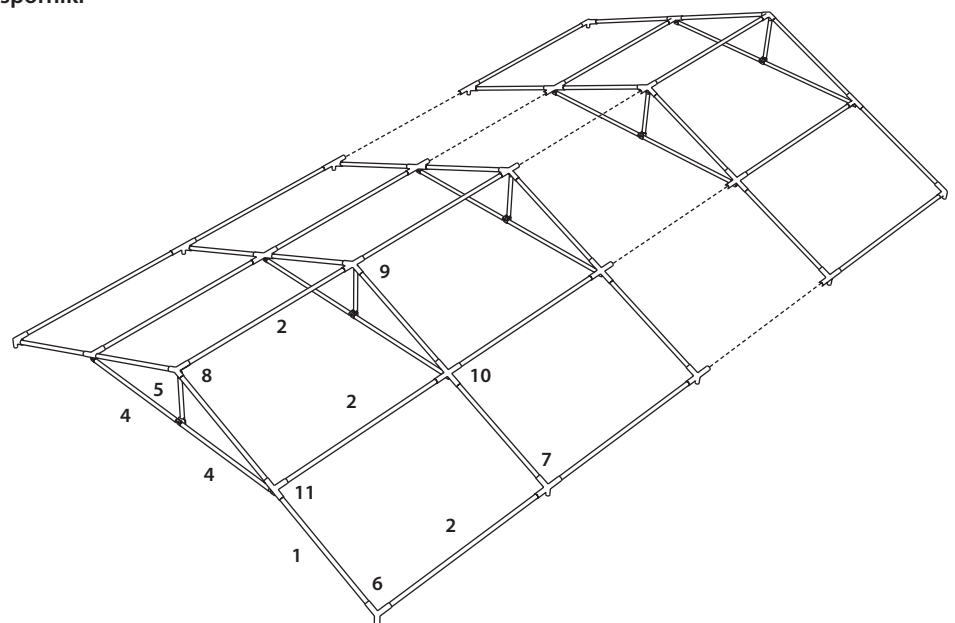

3 Podnieś jedną stronę stelażu namiotu i zamocuj nogi (3).

Nałóż dach (27) na ramę i przymocuj go za pomocą gumowych pętelek (24).

Uważaj, aby pętelki nie były za bardzo naprężone, ponieważ mogłoby to utrudnić montaż drugiej strony namiotu.

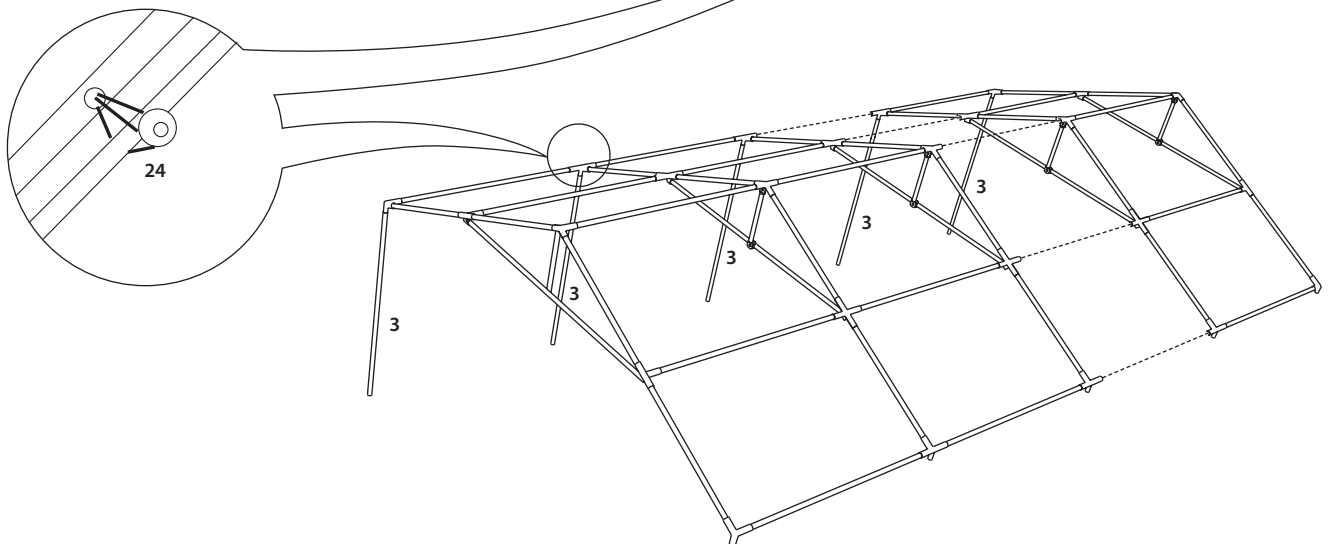
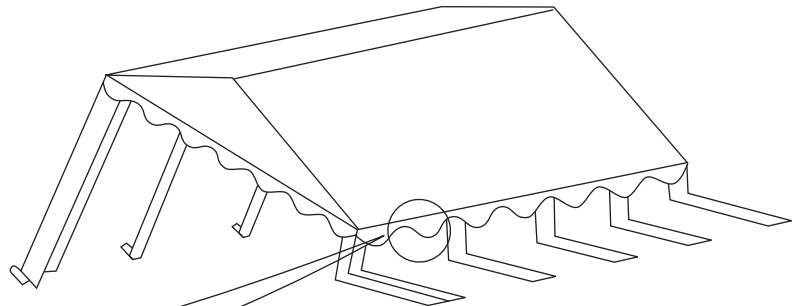

4 Włóż nogi po drugiej stronie namiotu a na ich dolnym końcu zamontuj stopki (12, 13).

Za pomocą długich szpilek (17) zamocuj stopki do podłoża. Szlufki dachu przymocuj do drążków (3) za pomocą haków (26). Następnie zmontuj ramę podstawy namiotu, używając odpowiednich drążków (2, 15) i łączników (14).

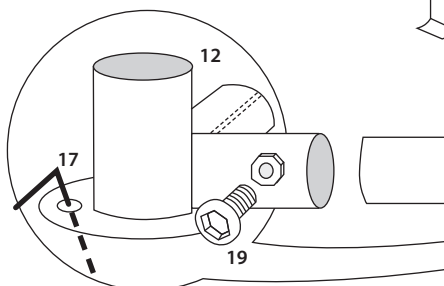
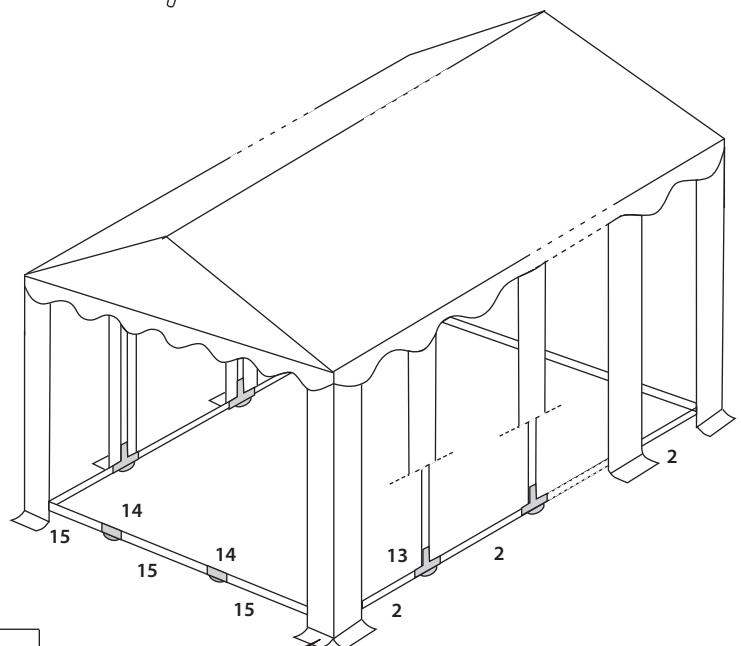

- 5** Rozłóż ściany boczne (28) i ściany szczytowe (29). Ściany boczne zamocuj za pomocą gumowych pętelek (23) do stelaża a ściany szczytowe za pomocą krótszych gumowych pętelek (24) bezpośrednio do dachu. Za pomocą krótszych szpilek (18) przymocuj ściany szczytowe do podłoża. W każdym narożniku namiotu naciągnij linkę naciągową i zamocuj ją do podłoża za pomocą wkręcanego haka (16).

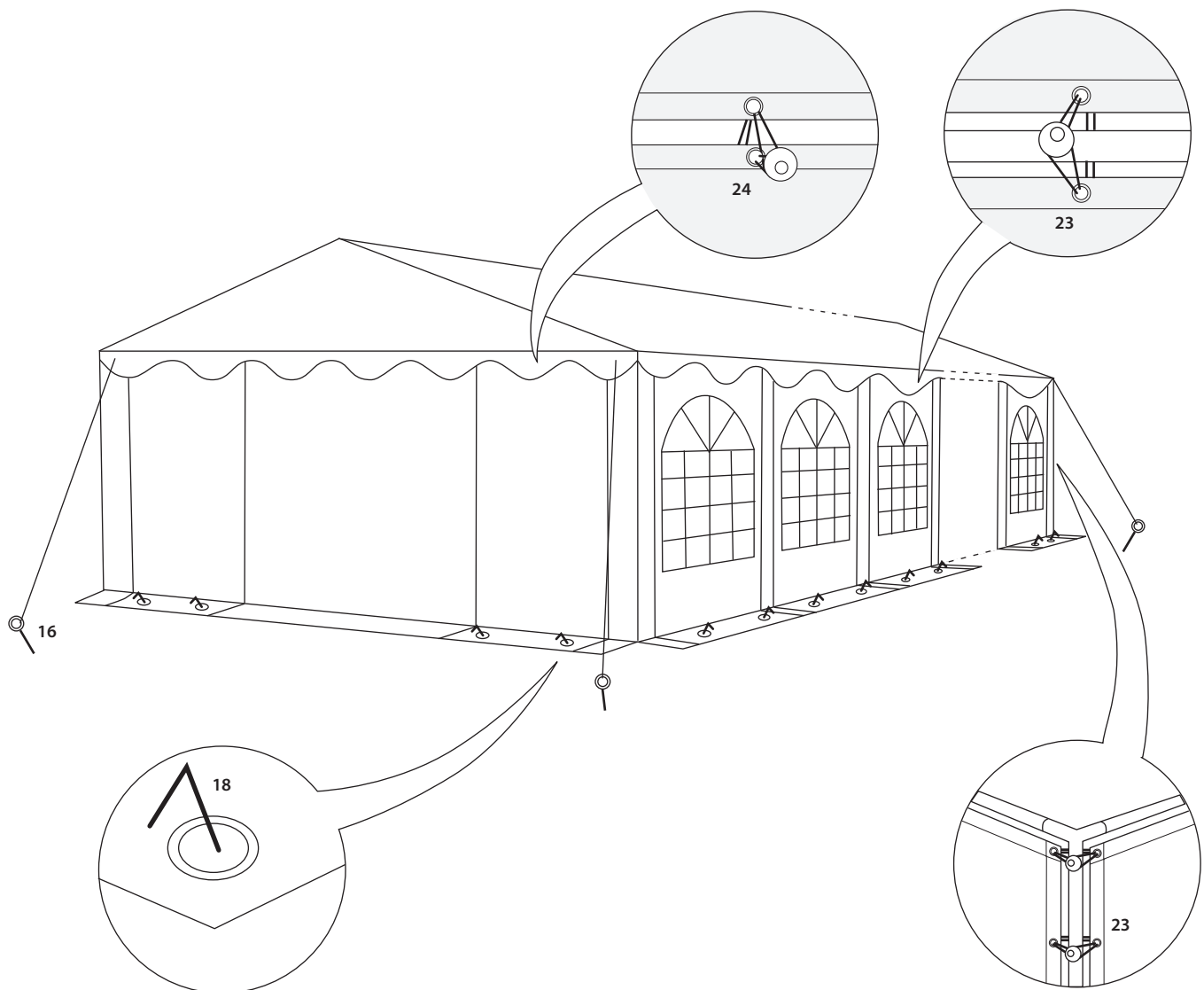

Czyszczenie i konserwacja











Dach i ściany boczne można myć wodą z mydłem. Ślady pleśni i plamy usuwać słabym roztworem chloru. Przestrzegać wskazówek producenta. Aby wykluczyć ryzyko powstania odbarwień, roztwór wypróbować najpierw w niewidocznym miejscu.

Uwaga! Nie wolno składać i pakować wilgotnego namiotu. Przed złożeniem namiot musi całkowicie wyschnąć.

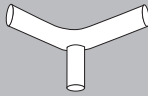
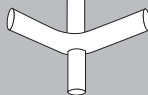

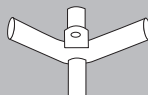

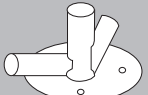
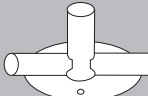
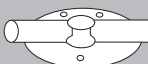



Ostrzeżenie

1. Należy zachować ostrożność podczas rozstawiania i składania namiotu, aby uniknąć jego uszkodzenia.
2. Stelaża nie narażać na zbyt duże obciążenia, ponieważ mogłoby to spowodować jego uszkodzenie.
3. Namioty są przeznaczone do użytku czasowego i w przypadku niesprzyjających warunków atmosferycznych należy je zdemontować.
4. Namiot rozstawiać w odpowiedniej odległości od przewodów wodnych, gazowych i elektrycznych, aby ich nie uszkodzić.
5. W przypadku używania odpowiednich grzejników (np. poprosić o radę sprzedawcę) należy je ustawiać w odległości nie mniejszej niż 1,2 metra od plandeki. Pod żadnym pozorem nie wolno używać otwartego ognia ani grzejników z otwartym płomieniem, np. parasoli grzewczych, promienników ogrodowych, nagrzewnic gazowych itp.
6. Osoba rozstawiająca namiot jest odpowiedzialna za jego właściwe przytwierdzenie do podłoża i tym samym za bezpieczeństwo.

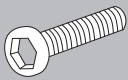
Inhoud

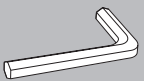
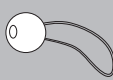
Artikelnr.	Beschrijving	ID-nummer		5x6m	5x8m	5x10m	5x12m
30053	Stang 1218 mm 38-38	1		16	20	24	28
30055	Stang 1940 mm 38-38	2		21	28	35	42
30056	Stang 1920 mm 38-38 met gaten	3		8	10	12	14
30058	Stang 1275 mm Daksteun 5-Serie horizontaal	4		8	10	12	14
30060	Stang 470 mm Daksteun 5-Serie verticaal	5		4	5	6	7
30076	3-voud. verbinding 110°	6		4	4	4	4
30077	4-voud. verbinding 110°	7		4	6	8	10
30071	3-voud. verbinding 140°	8		2	2	2	2
30079	4-voud. verbinding 140°	9		2	3	4	5
30070	Kruisstuk	10		4	6	8	10
30069	T-stuk	11		4	4	4	4
30066	3-voud. hoekverbinding - voet	12		4	4	4	4
30067	3-voud. verbinding - voet	13		4	6	8	10
30068	2-voud. verbinding - voet	14		4	4	4	4
30432	Stang 1.600 mm 38-38	15		6	6	6	6
30044	Schroefhaken	16		4	4	4	4

Inhoud

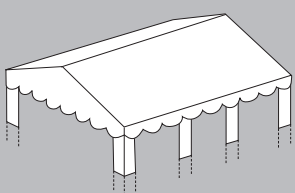
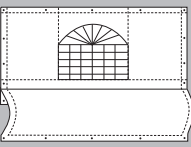
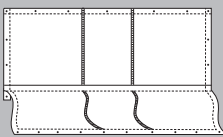
Artikelnr.	Beschrijving	ID-nummer		5x6m	5x8m	5x10m	5x12m
30046	Aardpen 6x180 mm	17		8	10	12	14
30047	Aardpen 4x160 mm	18		36	42	48	54
30383	Schroef 10 mm	19		102	128	154	180
30384	Schroef 30 mm	20		16	20	24	28
30052	Vleugelmoer	21		16	20	24	28
30382	Inbussleutel	22		1	1	1	1
30430	Rubberen lus 14 cm type 1	23		123	147	171	195
30429	Rubberen lus 5 cm type 1	24		22	22	22	22
30050	Spanlijn 3 m	25		4	4	4	4
30051	Dakhaken	26		8	10	12	14
	Dak	27		1	1	1	1
	Zijwand	28		6	8	10	12
	Eindwand	29		2	2	2	2

Gebruiksaanwijzing

1 Zoek een egale ondergrond voor de tent. Pak de het karton uit en controleer of alle hier opgesomde onderdelen aanwezig zijn.

Stel het frame voor het dak samen door de delen 6 tot 11 aan de stangen (delen 1 en 2) te monteren en ter bevestiging de schroeven vast aan te draaien.

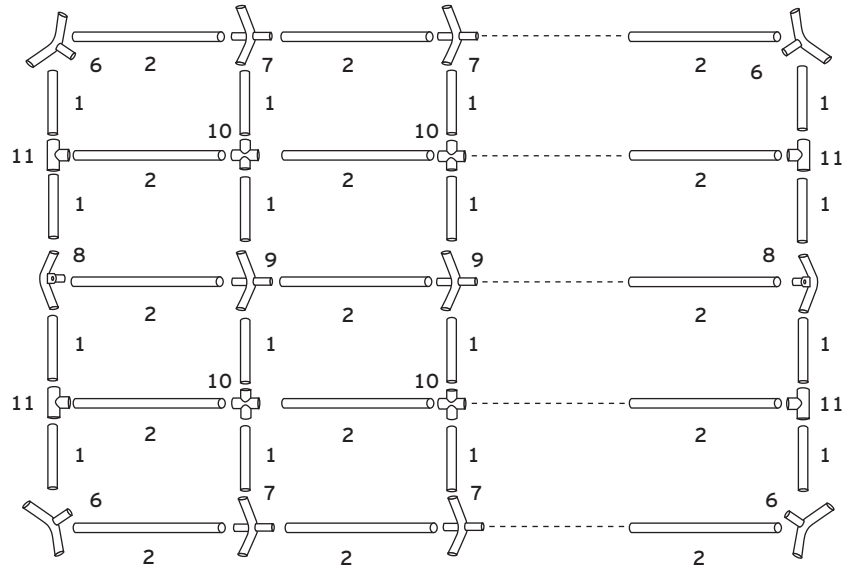

2 Bevestig de versterkingssteunen (delen 4 en 5) met schroeven (20) en vleugelmoeren (21).

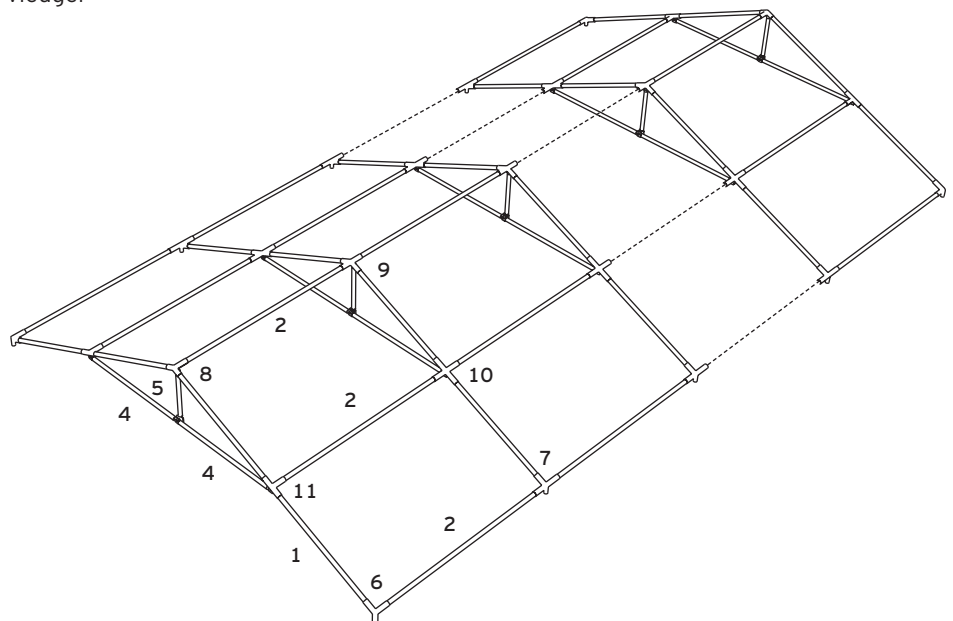

3 Hef één zijde van het tentframe op, en breng de benen (3) aan.

Breng het dak (27) aan op het frame en bevestig het met de rubberen lussen (24).

Let er op de rubberen lussen niet te strak te spannen, om het aanbrengen van de andere zijde niet te bemoeilijken.

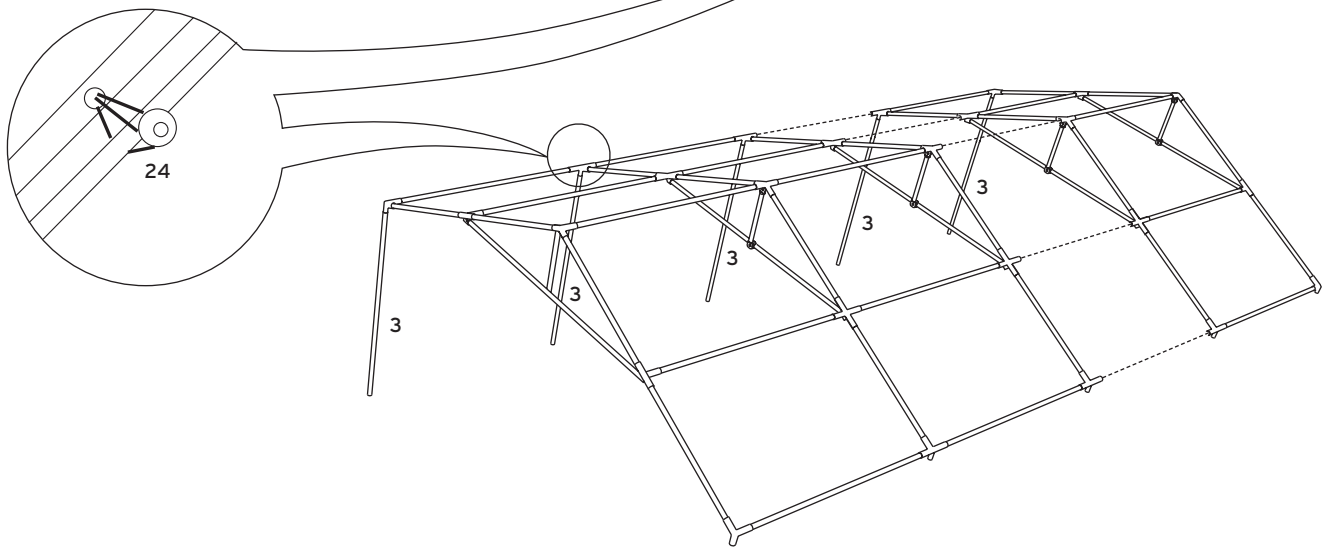
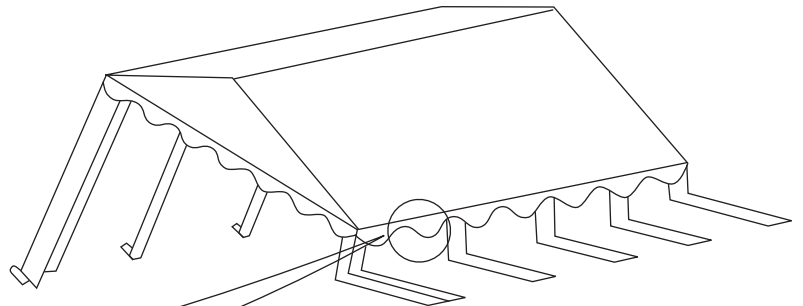

4 Steek de benen aan de tegenoverliggende zijde in en monteer de voeten aan het onderste uiteinden (12, 13). Gebruik de lange aardpennen (17) om de voeten aan de grond te bevestigen. De dakstroken worden met haken (26) aan de stangen (3) bevestigd. Aansluitend vervolledigt u het vloerframe met de juiste stangen (2, 15) en verbindingen (14).

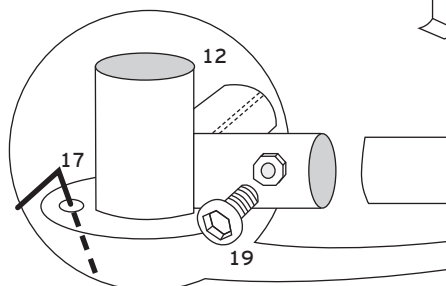
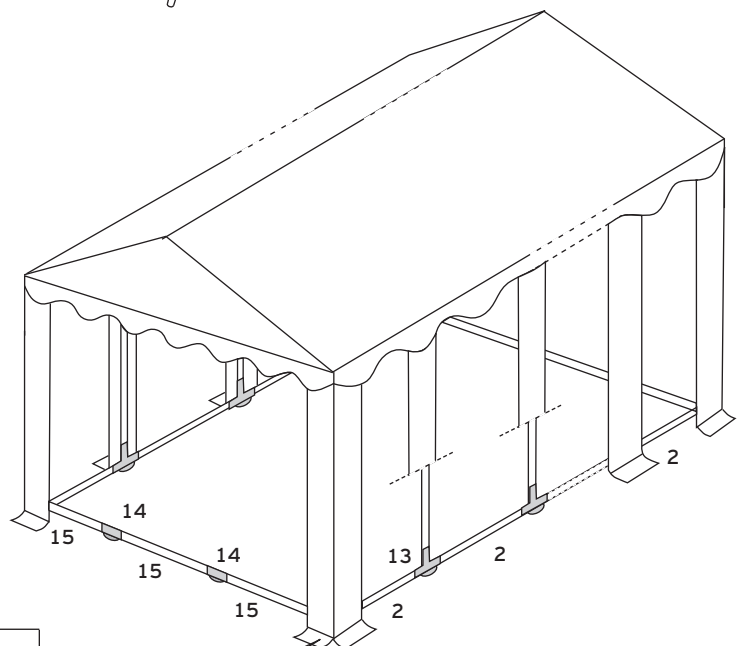

- 5** Spreid de zijwanden (28) en de eindwanden (29) uit en bevestig de zijwanden met de rubberen lussen (23) aan het frame en de eindwanden met de korte rubberen lussen (24) direct aan het dak. Met de korte aardpennen (18) bevestigt u de eindwanden aan de ondergrond. Vanaf elke hoek van de tent vetrekt een spanlijn. Ze wordt met een schroefhaak (16) aan de grond bevestigd.

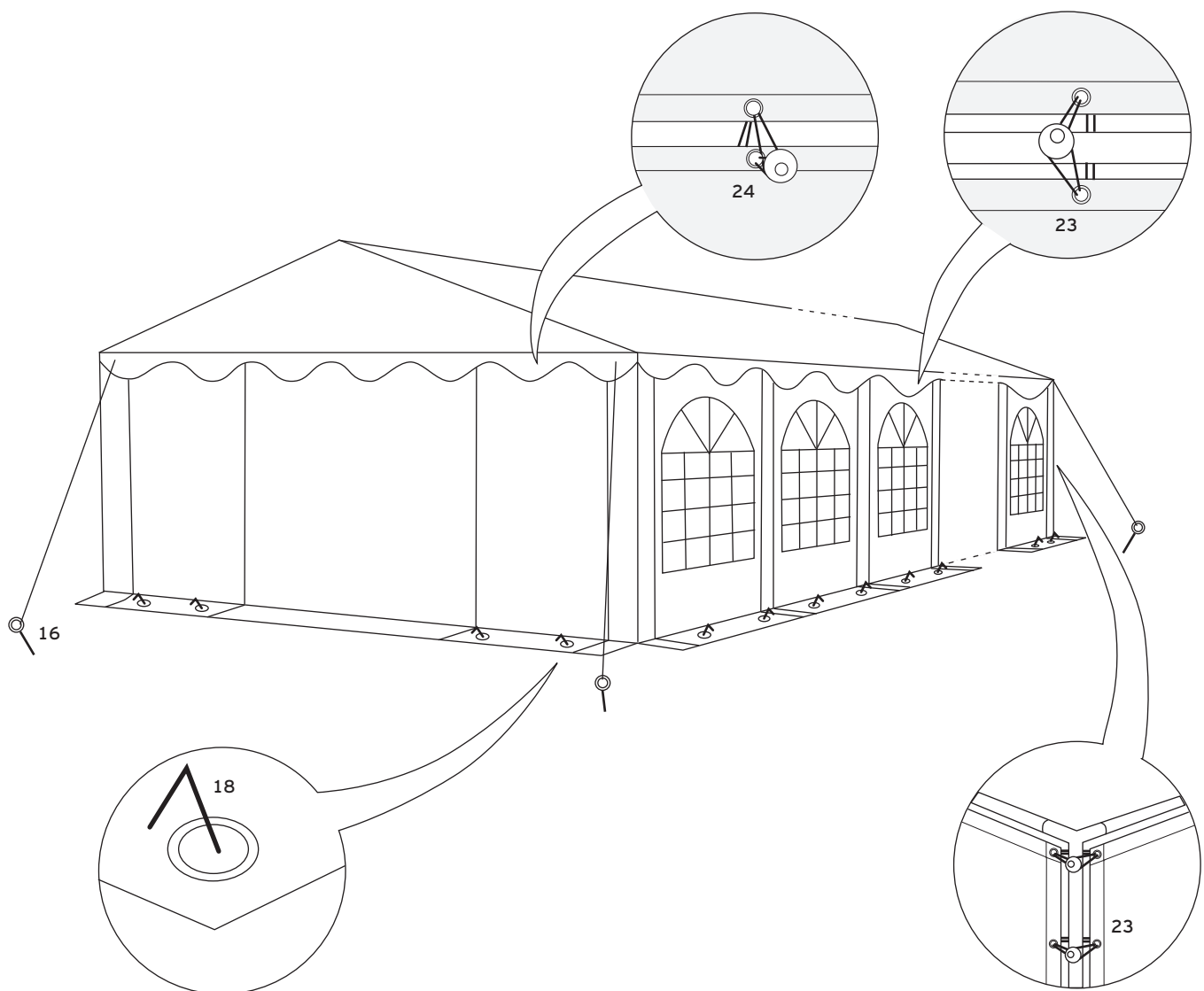

Reiniging en onderhoud











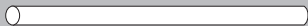

Dak en zijdelen kunnen met een zeepsopje worden afgewassen. Schimmels en vochtvlekken verwijdt u met een zachte chlooroplossing. Volg de aanwijzingen van de fabrikant op, en test de chlooroplossing op een niet zichtbare plaats, om zeker te zijn dat er geen verkleuring optreedt.

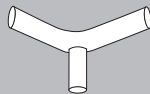
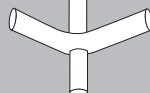
Let op! De partytent mag niet in natte toestand worden gedemonteerd en verpakt. Laat haar voordien volledig opdrogen.

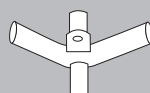



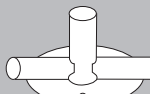
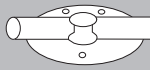



Waarschuwing

1. Let er op de tent voorzichtig te behandelen, om defecten te vermijden.
2. Niet te veel kracht gebruiken bij het hanteren van de stangen: ze kunnen anders beschadigd raken.
3. Tenten zijn bedoeld als tijdelijke beschutting en moeten bij slechte weersomstandigheden gedemonteerd worden.
4. Zorg steeds voor een aangepaste afstand tot slangen, gas- en elektriciteitsleidingen, om deze niet te beschadigen.
5. Bij gebruik van een geschikt verwarmingsapparaat (zie voor nadere informatie de vakhandel) moet een afstand van minstens 1,2 m tot om het even welk vlak worden aangehouden. Open vuur en verwarmingsapparaten met open vlam zoals terrasverwarmingen, gaskachels e.d. mogen in geen geval worden gebruikt.
6. De bouwer is verantwoordelijk voor een aangepaste verankering en daarmee voor de veiligheid van de tent.

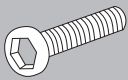
Contenu

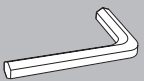
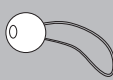
Code art.	Désignation	N° de repère		5x6m	5x8m	5x10m	5x12m
30053	Tube 1218 mm 38-38	1		16	20	24	28
30055	Tube 1940 mm 38-38	2		21	28	35	42
30056	Tube 1920 mm 38-38 avec trous	3		8	10	12	14
30058	Tube 1275 mm Tirant de toit Série 5 horizontal	4		8	10	12	14
30060	Tube 470 mm Tirant de toit Série 5 vertical	5		4	5	6	7
30076	Raccord 3 axes 110°	6		4	4	4	4
30077	Raccord 4 axes 110°	7		4	6	8	10
30071	Raccord 3 axes 140°	8		2	2	2	2
30079	Raccord 4 axes 140°	9		2	3	4	5
30070	Croisillon	10		4	6	8	10
30069	Té	11		4	4	4	4
30066	Raccord 3 axes - pied	12		4	4	4	4
30067	Raccord 3 axes - pied	13		4	6	8	10
30068	Raccord 2 axes - pied	14		4	4	4	4
30432	Tube 1600 mm 38-38	15		6	6	6	6
30044	Crochet à visser	16		4	4	4	4

Contenu

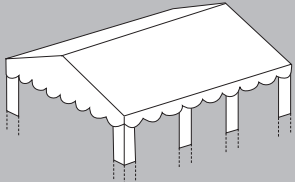
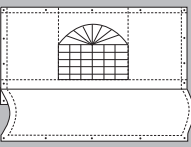
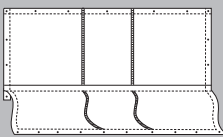
Code art.	Désignation	N° de repère		5x6m	5x8m	5x10m	5x12m
30046	Piquet de sol 6x180 mm	17		8	10	12	14
30047	Piquet de sol 4x160 mm	18		36	42	48	54
30383	Vis 10 mm	19		102	128	154	180
30384	Vis 30 mm	20		16	20	24	28
30052	Écrou à oreilles	21		16	20	24	28
30382	Clé 6 pans	22		1	1	1	1
30430	Boucle caoutchouc 14 cm type 1	23		123	147	171	195
30429	Boucle caoutchouc 5 cm type 1	24		22	22	22	22
30050	Cordeau tendeur 3 m	25		4	4	4	4
30051	Crochet de toit	26		8	10	12	14
	Toit	27		1	1	1	1
	Paroi latérale	28		6	8	10	12
	Paroi d'extrémité	29		2	2	2	2

Mode d'emploi

1 Cherchez un endroit où le sol est plat pour installer la tente. Déballez les cartons et vérifiez que toutes les pièces figurant dans la liste ci-dessus sont présentes.

Assemblez le cadre du toit en montant les pièces 6 à 11 sur les tubes (pièces 1 et 2) et en bloquant les vis pour fixer le tout.

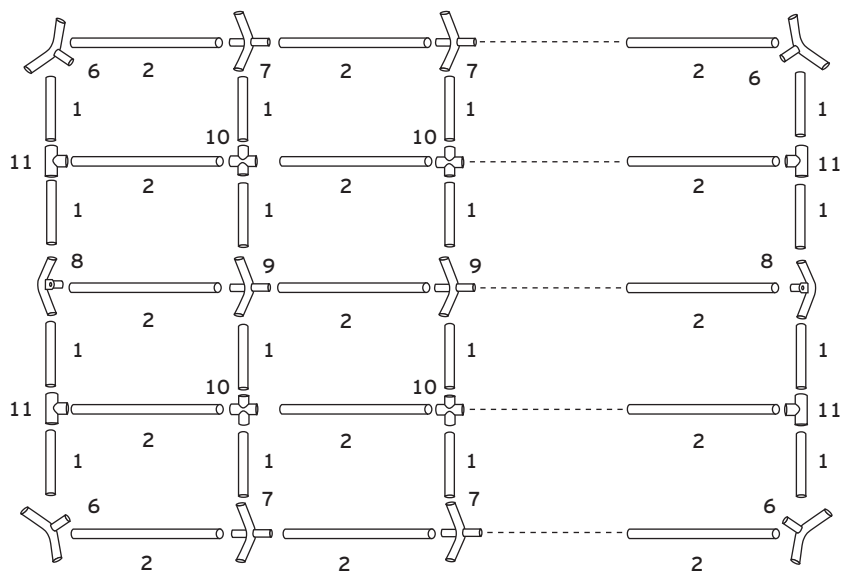

2 Fixez les tirants de renfort (pièces 4 et 5) au moyen des vis (20) et des écrous à oreilles (21).

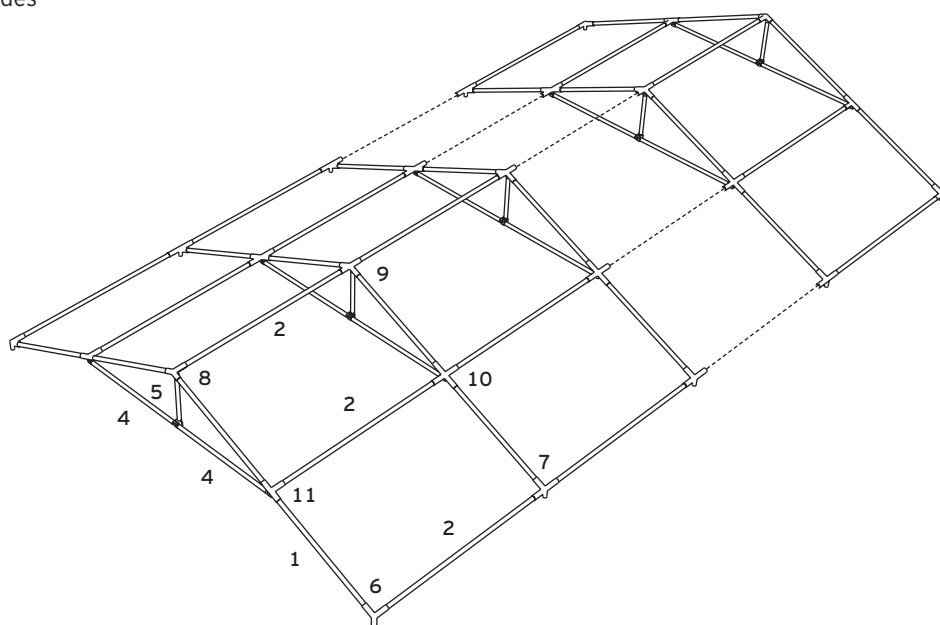

3

Soulevez un côté de l'ossature de la tente et emmanchez les montants (3). Posez le toit (27) sur le cadre et fixez-le au moyen des boucles en caoutchouc (24). Évitez de tendre exagérément les boucles en caoutchouc afin de ne pas rendre le montage de l'autre côté plus difficile.

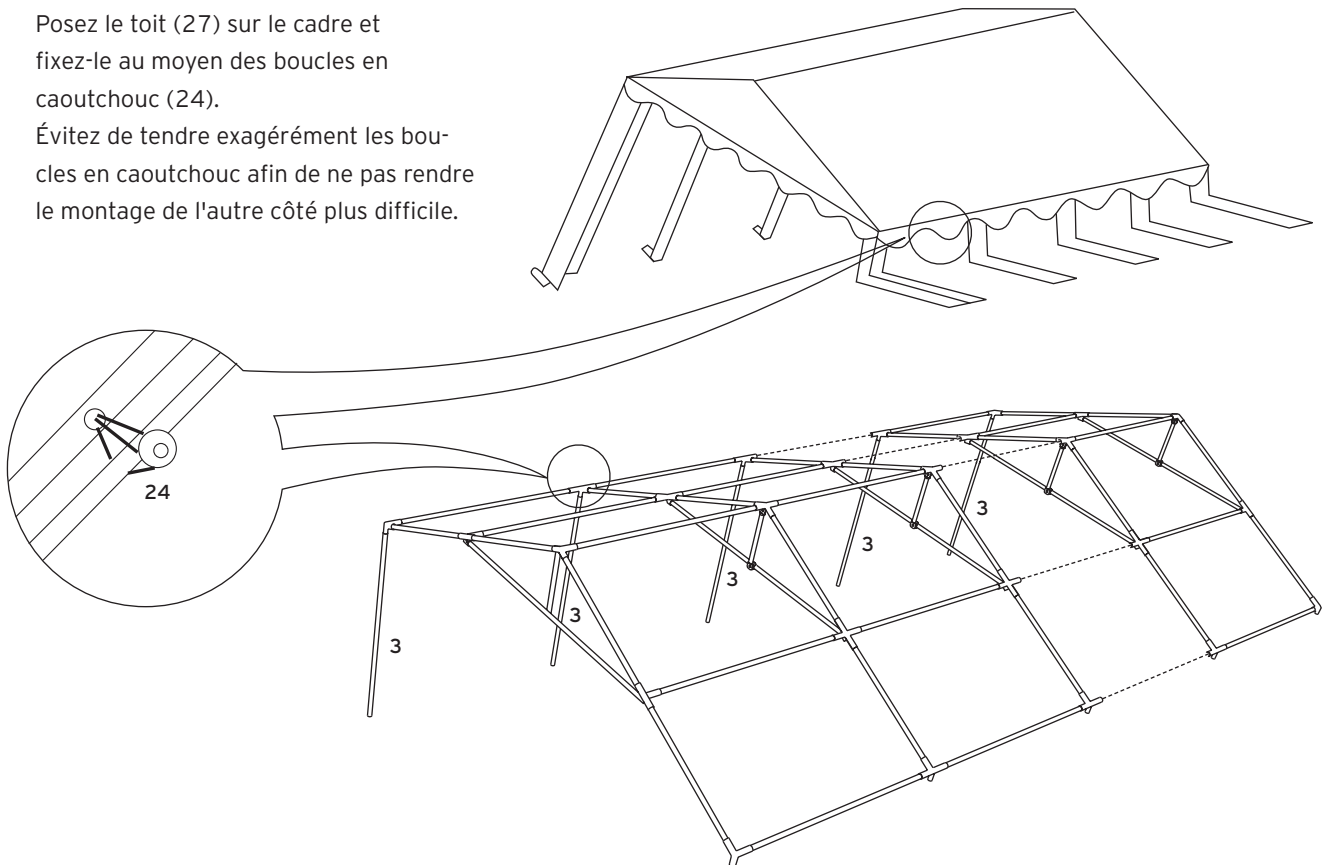

4

Emmanchez les montants du côté opposé et montez les pieds (12, 13) à leur extrémités inférieures. Utilisez les piquets longs (17) pour immobiliser les pieds au sol. L'habillage du toit se fixe aux tubes (3) au moyen de crochets (26). Ensuite, complétez le montage du cadre de sol avec les tubes (2, 15) / raccords (14) correspondants.

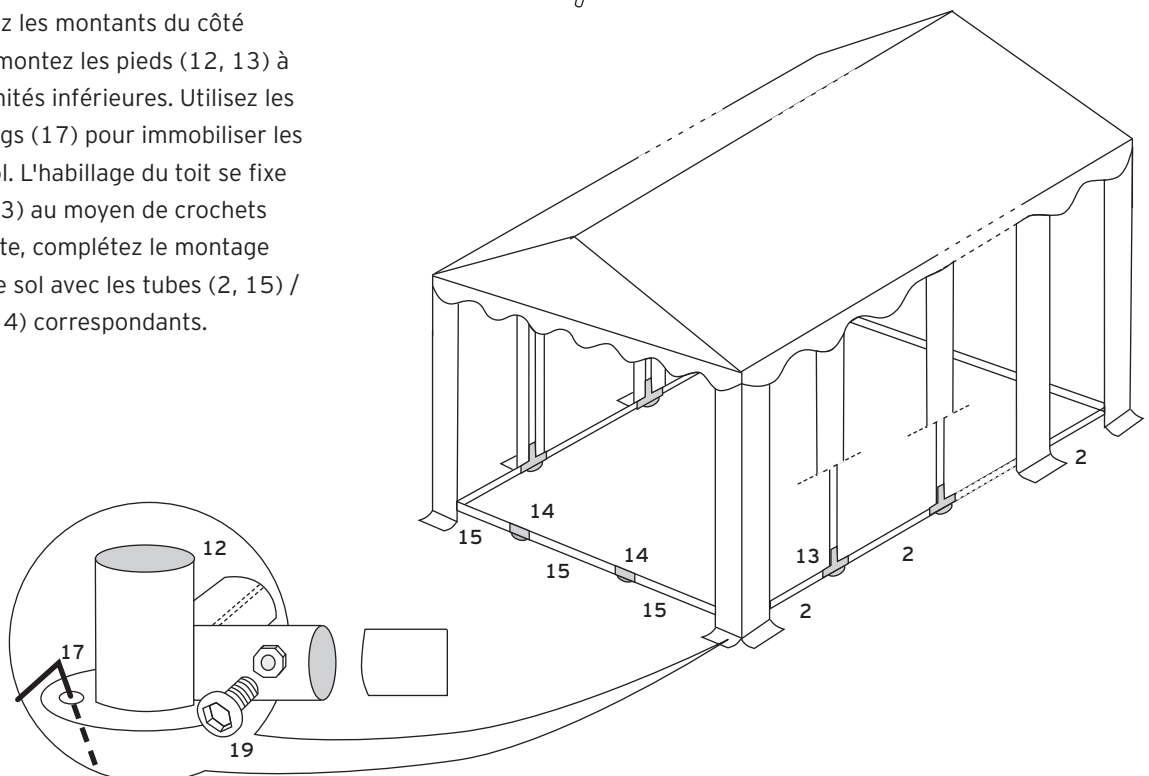

- 5** Écartez les parois latérales (28) et les parois d'extrémité (29) et fixez les parois latérales à l'ossature au moyen des boucles en caoutchouc (23) et les parois d'extrémité directement au toit au moyen des boucles courtes (24). Fixez les parois d'extrémité au sol à l'aide des piquets courts (18). Le cordeau tendeur part de chaque angle de la tente et il est tendu au sol au moyen des tendeurs à vis (16).

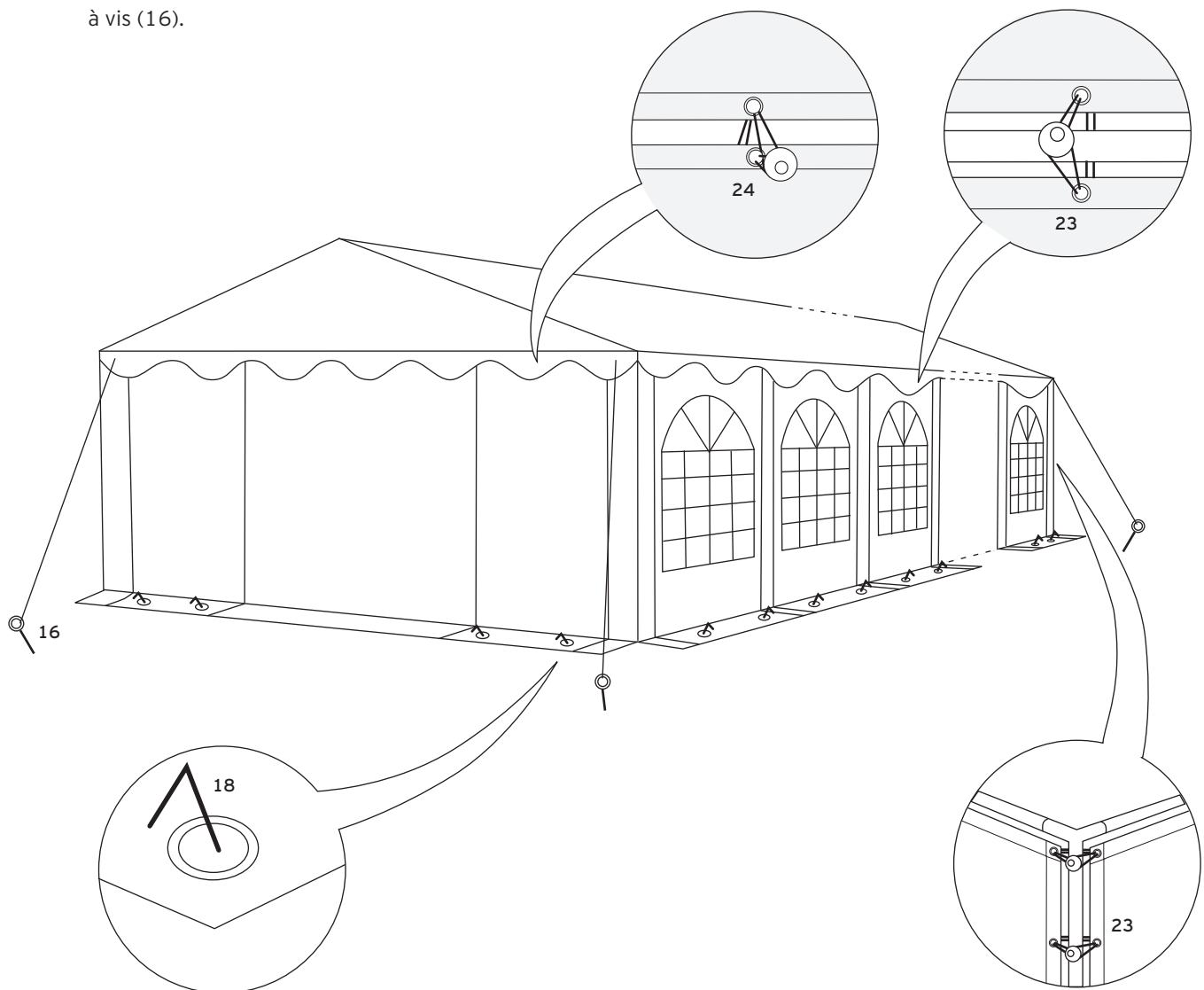

Nettoyage et entretien











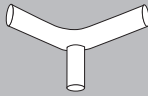
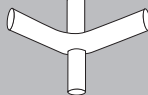

Le toit et les parois se lavent à l'eau savonneuse. Pour éliminer les moisissures et les taches d'humidité, utilisez une solution légèrement chlorée. Suivez les instructions du fabricant et testez la solution chlorée à un endroit non visible pour vous assurer qu'elle ne provoque pas de décoloration.

Attention ! La tente de réception ne doit en aucun cas être repliée et rangée lorsqu'elle est humide. Laissez-la sécher complètement auparavant.

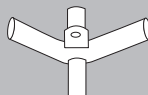



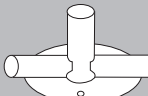
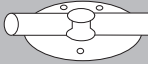



Avertissements

1. Veillez à manipuler la tente avec précautions pour éviter de la détériorer.
2. Évitez de forcer sur les tubes et les raccords, au risque de les endommager.
3. Les tentes sont destinées à des usages de loisirs temporaires et elles doivent être démontées en cas de mauvais temps.
4. Veillez à respecter systématiquement une distance appropriée par rapport aux tuyaux, aux conduites de gaz ou aux lignes électriques afin d'éviter de les endommager.
5. En cas d'utilisation d'appareils de chauffage adaptés (se renseigner par exemple auprès d'un vendeur spécialisé), respectez une distance minimum de 1,2 m par rapport à chaque matériau de bâchage. Les feux ouverts de même que les appareils de chauffage à flammes nues tels que champignons chauffants, radiateurs de terrasses, chauffages au gaz etc. ne doivent en aucun cas être utilisés.
6. L'installateur est responsable de l'ancrage adéquat et donc de la sécurité de la tente.

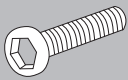
Obsah

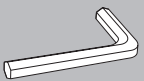
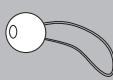
Č. výrobku	Popis	ID číslo		5×6 m	5×8 m	5×10 m	5×12 m
30053	Tyč 1218 mm 38-38	1		16	20	24	28
30055	Tyč 1940 mm 38-38	2		21	28	35	42
30056	Tyč 1920 mm 38-38 s otvory	3		8	10	12	14
30058	Tyč 1275 mm Střešní výztuha Řada 5 horizontální	4		8	10	12	14
30060	Tyč 470 mm Střešní výztuha Řada 5 vertikální	5		4	5	6	7
30076	Rohová spojka se třemi konci 110°	6		4	4	4	4
30077	Rohová spojka se čtyřmi konci 110°	7		4	6	8	10
30071	Rohová spojka se třemi konci 140°	8		2	2	2	2
30079	Rohová spojka se čtyřmi konci 140°	9		2	3	4	5
30070	Křížová spojka	10		4	6	8	10
30069	T-spojka	11		4	4	4	4
30066	Rohová spojka se třemi konci – patka	12		4	4	4	4
30067	Spojka se třemi konci – patka	13		4	6	8	10
30068	Spojka se dvěma konci – patka	14		4	4	4	4
30432	Tyč 1600 mm 38-38	15		6	6	6	6
30044	Šroubovací háček	16		4	4	4	4

Obsah

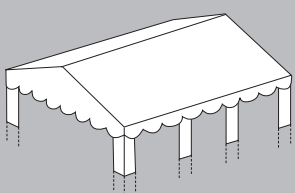
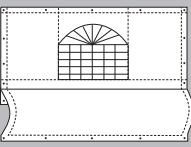
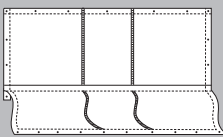
Č. výrobku	Popis	ID číslo		5×6 m	5×8 m	5×10 m	5×12 m
30046	Hřeb do země 6 × 180 mm	17		8	10	12	14
30047	Hřeb do země 4 × 160 mm	18		36	42	48	54
30383	Šroub 10 mm	19		102	128	154	180
30384	Šroub 30 mm	20		16	20	24	28
30052	Křídlová matice	21		16	20	24	28
30382	Imbusový klíč	22		1	1	1	1
30430	Pryžová smyčka 14 cm typ 1	23		123	147	171	195
30429	Pryžová smyčka 5 cm typ 1	24		22	22	22	22
30050	Napínací šňůra 3 m	25		4	4	4	4
30051	Střešní háček	26		8	10	12	14
	Střecha	27		1	1	1	1
	Boční stěna	28		6	8	10	12
	Koncová stěna	29		2	2	2	2

Návod k použití

1

Vyhledejte rovný poklad, na nějž stan umístíte. Vybalte kartony a zkontrolujte, zda obsahují veškeré zde uvedené díly.

Složte rám střechy: díly 6 až 11 namontujte na tyče (díly 1 a 2) a důkladně je připevněte pomocí šroubů.

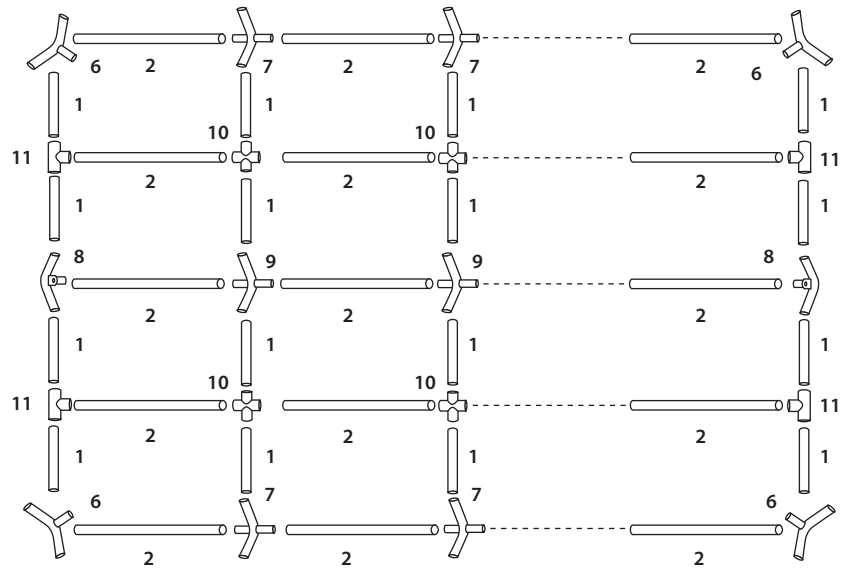

2

Pomocí šroubů (20) a křídlových matic (21) připevněte zesilovací výztuhy (díly 4 a 5).

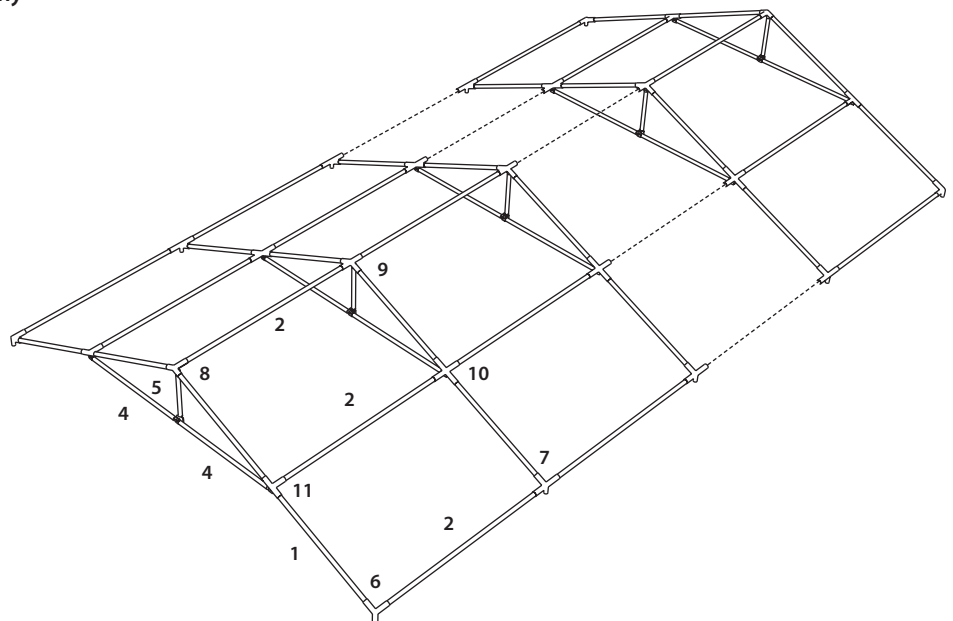

3 Nadzdvihněte jednu stranu kostry stanu a nasadte na ni nohy (3).

Položte na rám střechu (27) a připevněte ji pryžovými smyčkami (24).

Dejte pozor, abyste pryžové smyčky nenapnuli příliš, a neztížili si tak instalaci druhé strany.

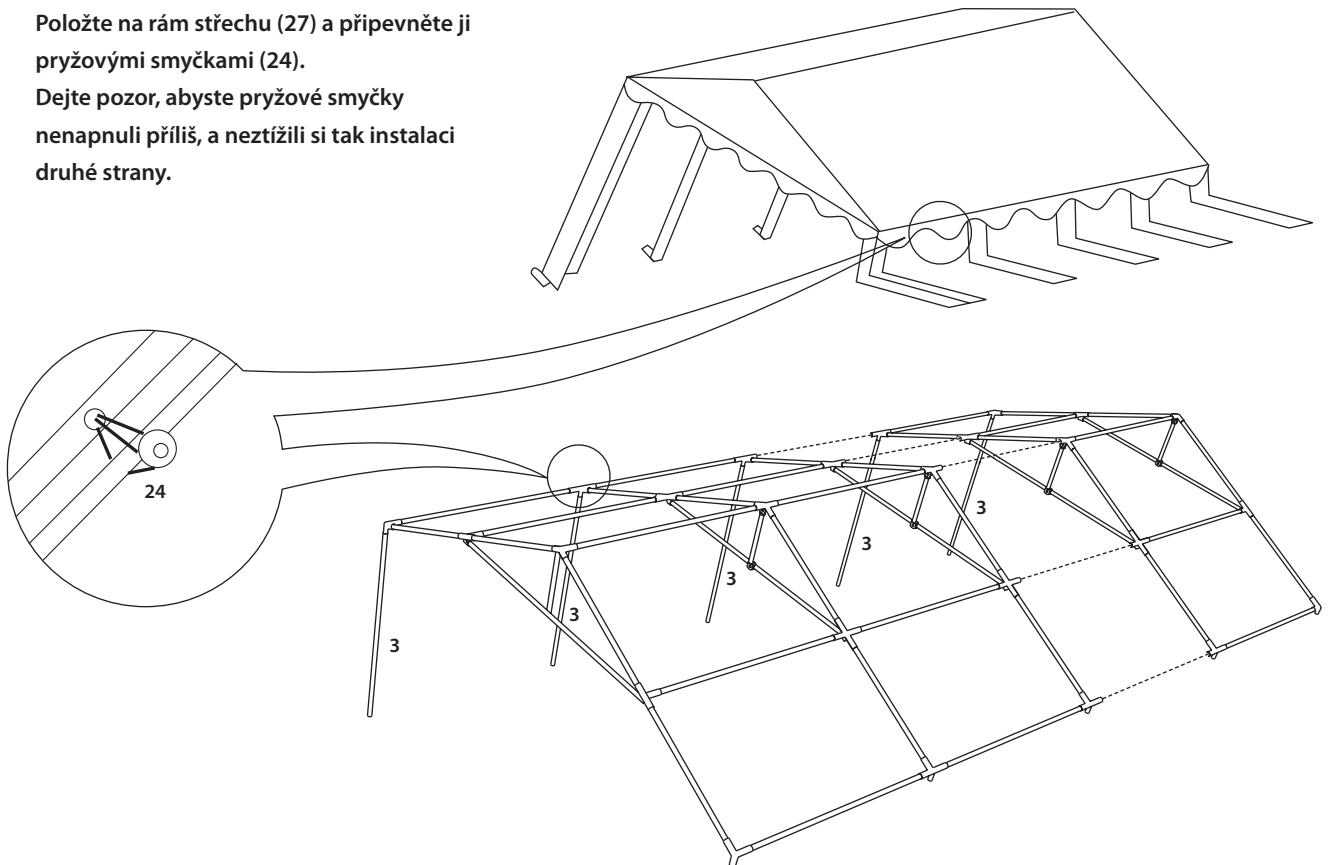

4 Nasadte nohy na protilehlou stranu a na spodní konec namontujte patky (12, 13).

K připevnění patek k zemi použijte dlouhé hřeby do země (17). Střešní lemy připevněte k tyčím (3) pomocí háčků (26). Spodní rám následně doplňte příslušnými tyčemi (2, 15) a spojkami (14).

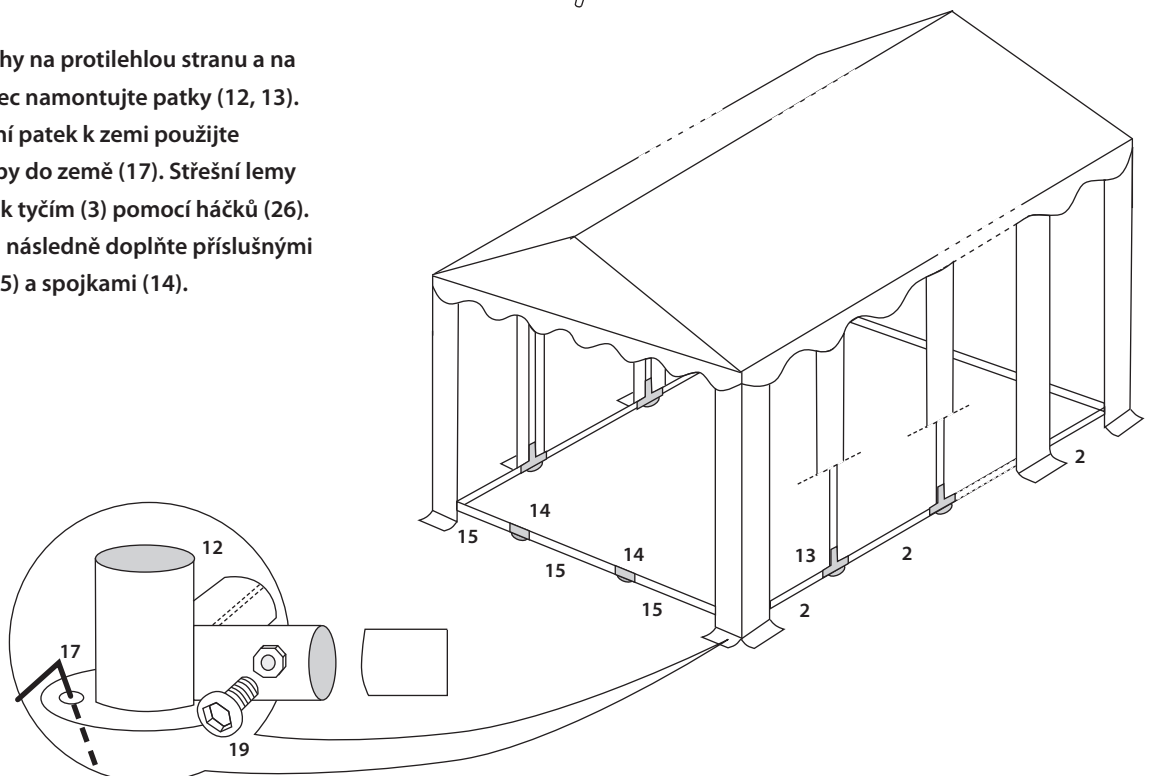

- 5** Rozprostřete boční (28) a koncové stěny (29). Boční stěny připevněte pryžovými smyčkami (23) ke kostře, koncové stěny pak krátkými pryžovými smyčkami (24) přímo ke střeše. Pomocí krátkých hřebů do země (18) připevněte koncové stěny k zemi. Napínací šňůra se natahuje z každého rohu stanu ak zemi se kotví pomocí šroubovacího háčku (16).

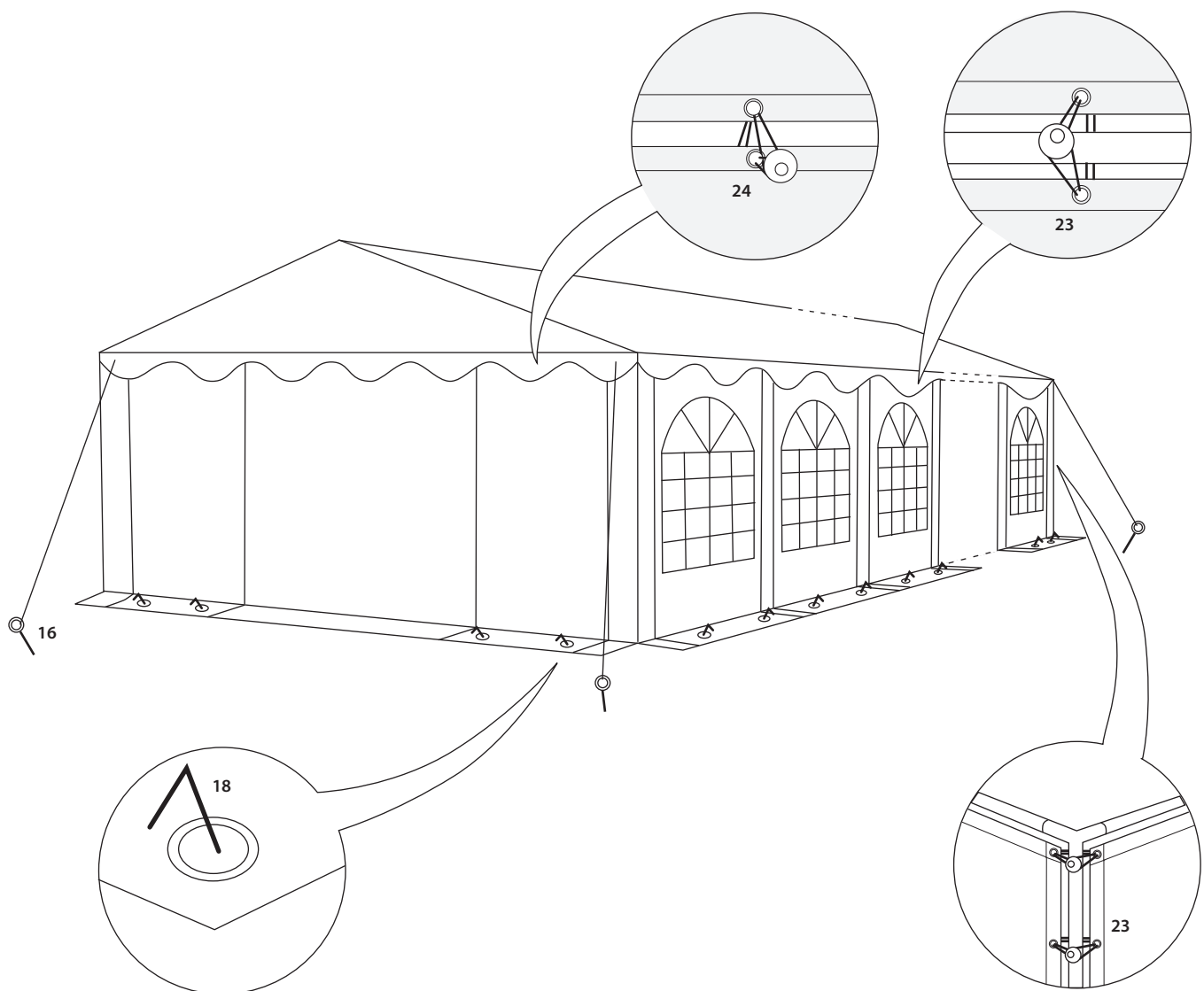

Čištění a údržba











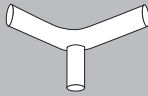
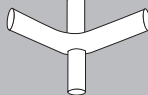

Střechu a boční části lze omývat mýdlovým roztokem. Plíseň a skvrny vzniklé vlhkostí odstraňujte jemným chlorovým roztokem. Dodržujte pokyny výrobce a chlorový roztok nejprve vyzkoušejte na místě, které není vidět. Tímto způsobem se ujistěte, zda nedochází ke změně zbarvení.

Pozor! Party stan se nesmí skládat ani balit ve vlhkém stavu. Nechejte jej před tím zcela vyschnout.

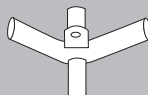



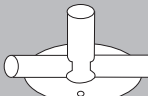
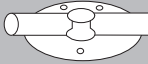



Varování

1. Se stanem manipulujte opatrně, předejdete tak jeho poškození.
2. Na soutyčí nepoužívejte nadměrnou sílu, jinak by mohlo dojít k jeho poškození.
3. Stany jsou určeny k dočasnému pobytu a neměly by se sestavovat za nepříznivých povětrnostních podmínek.
4. Vždy udržujte vhodný odstup od hadic, plynového a elektrického vedení, aby nedošlo k jejich poškození.
5. Při používání vhodných topných těles (informace získáte například ve specializovaných obchodech) dodržujte minimální odstup 1,2 metru od plachty. V žádném případě byste neměli používat otevřený oheň a topná tělesa, která otevřený oheň využívají, například topné hříby, terasové sálače, plynová topidla atd.
6. Sestavující osoba odpovídá za přiměřené ukotvení, a tím pádem za bezpečnost stanu.

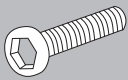
Contenido

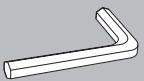
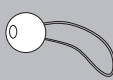
Nº de art.	Descripción	Nº de ident.		5x6m	5x8m	5x10m	5x12m
30053	Barra 1.218 mm 38-38	1		16	20	24	28
30055	Barra 1.940 mm 38-38	2		21	28	35	42
30056	Barra 1.920 mm 38-38 con agujeros	3		8	10	12	14
30058	Barra 1.275 mm Travesaño del techo Serie 5 horizontal	4		8	10	12	14
30060	Barra 470 mm Travesaño del techo Serie 5 vertical	5		4	5	6	7
30076	Conector angular triple 110°	6		4	4	4	4
30077	Conector angular cuádruple 110°	7		4	6	8	10
30071	Conector angular triple 140°	8		2	2	2	2
30079	Conector angular cuádruple 140°	9		2	3	4	5
30070	Pieza en cruz	10		4	6	8	10
30069	Pieza en T	11		4	4	4	4
30066	Conector angular triple - pie	12		4	4	4	4
30067	Conector triple - pie	13		4	6	8	10
30068	Conector doble - pie	14		4	4	4	4
30432	Barra 1.600 mm 38-38	15		6	6	6	6
30044	Gancho roscado	16		4	4	4	4

Contenido

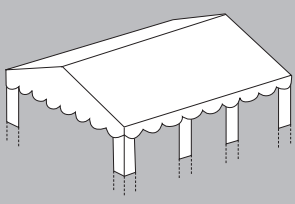
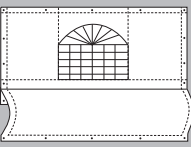
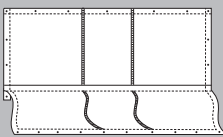
Nº de art.	Descripción	Nº de ident.		5x6m	5x8m	5x10m	5x12m
30046	Clavo de tierra 6x180 mm	17		8	10	12	14
30047	Clavo de tierra 4x160 mm	18		36	42	48	54
30383	Tornillo 10 mm	19		102	128	154	180
30384	Tornillo 30 mm	20		16	20	24	28
30052	Tuerca de mariposa	21		16	20	24	28
30382	Llave Allen	22		1	1	1	1
30430	Pasador de goma 14 cm tipo 1	23		123	147	171	195
30429	Pasador de goma 5 cm tipo 1	24		22	22	22	22
30050	Cuerda tensora 3 m	25		4	4	4	4
30051	Gancho de techo	26		8	10	12	14
	Techo	27		1	1	1	1
	Pared lateral	28		6	8	10	12
	Pared final	29		2	2	2	2

Manual de instrucciones

1

Busque una superficie llana para instalar la carpa. Abra el embalaje y compruebe si están todas las piezas que aquí se enumeran.

Ensamble el armazón del techo montando las piezas de 6 a 11 en las barras (piezas 1 y 2) y apriete los tornillos para fijarlas.

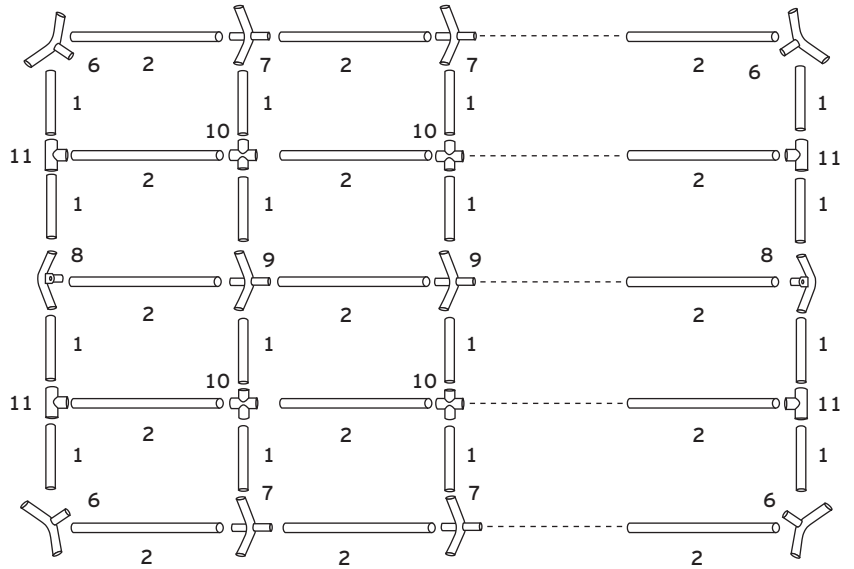

2

Fije los travesaños de refuerzo (piezas 4 y 5) con tornillos (20) y tuercas de mariposa (21).

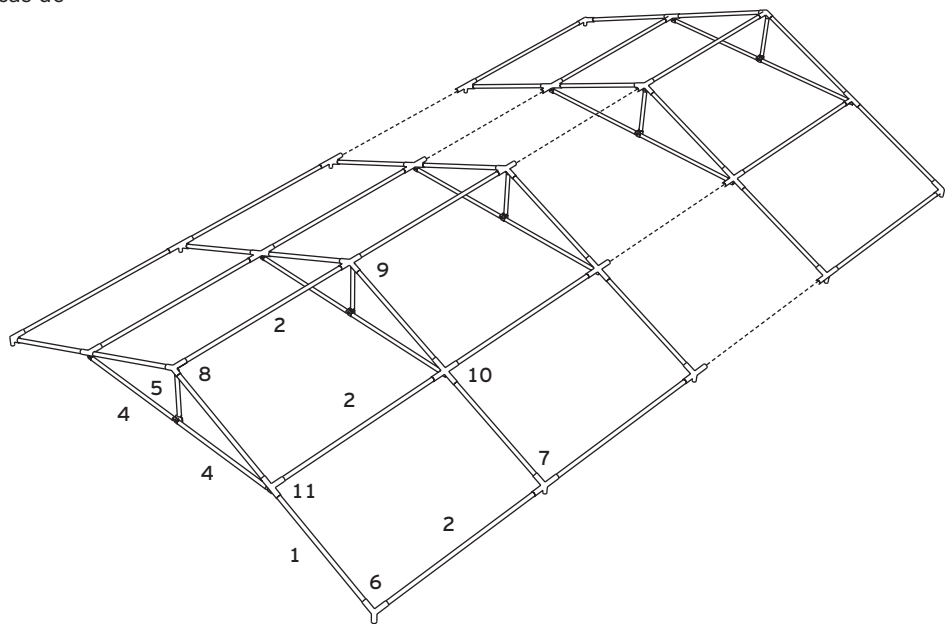

3

Levante una parte de la estructura de la carpa y coloque las patas (3).
Coloque el techo (27) sobre el armazón y sujételo con los pasadores de goma (24).
Procure que los pasadores de goma no queden muy tirantes para no dificultar la colocación de la otra parte.

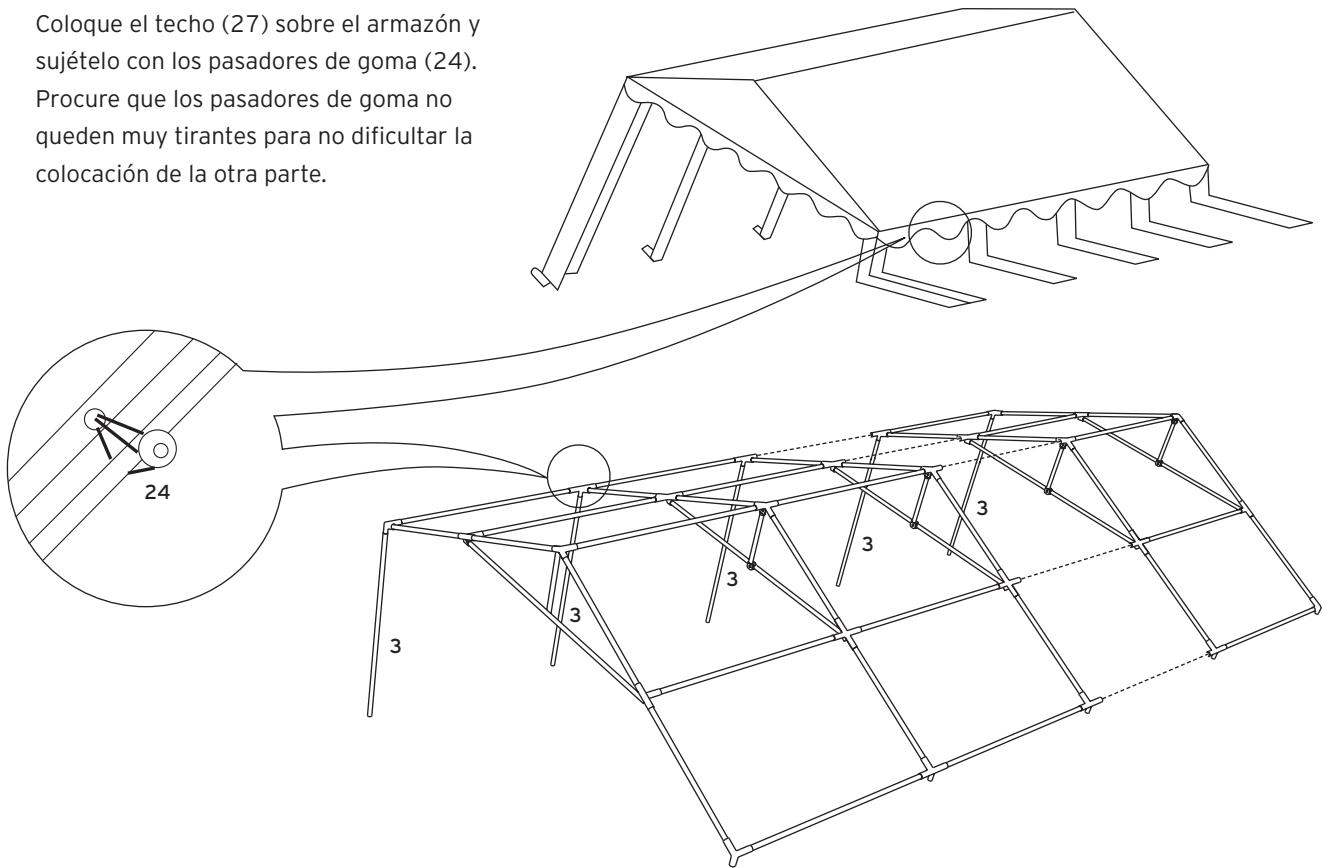

4

Coloque las patas de la parte contraria y monte los pies (12, 13) en los extremos inferiores. Utilice los clavos de tierra largos (17) para sujetar los pies al suelo. La cubierta del techo se fija a las barras (3) con ganchos (26). A continuación, complete la estructura de la base con las barras (2, 15) y conectores (14) correspondientes.

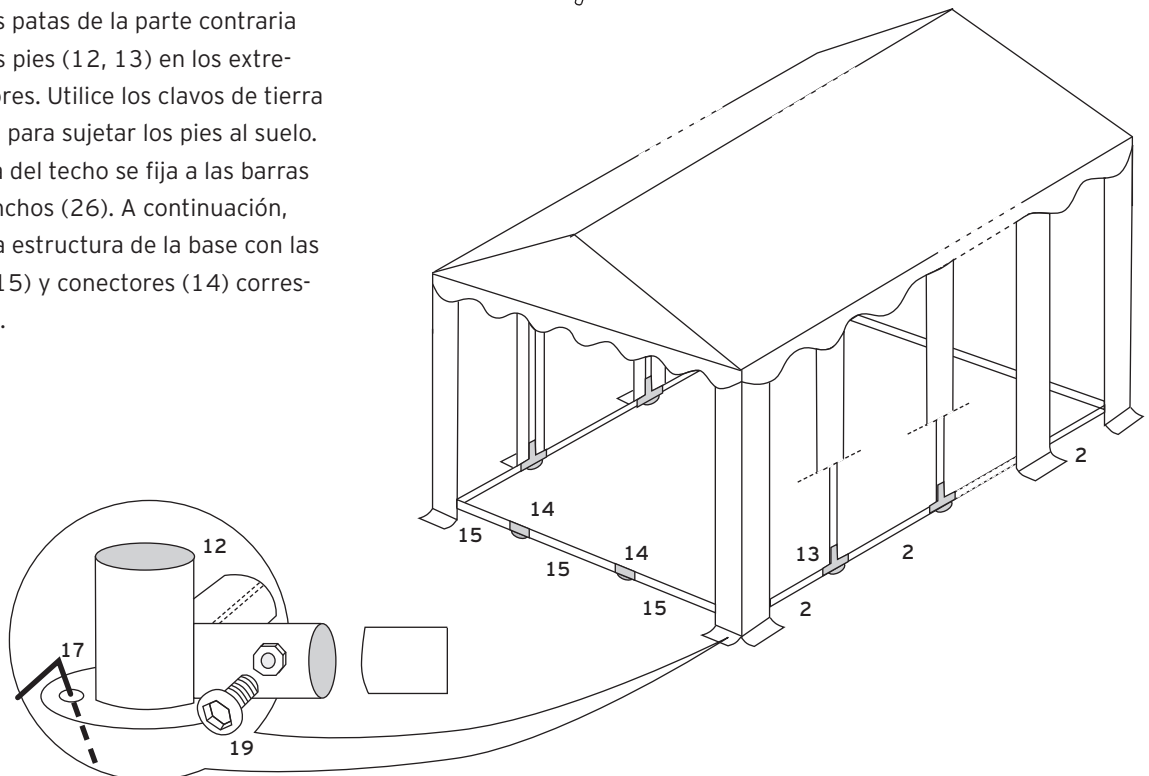

- 5** Extienda las paredes laterales (28) y finales (29) y sujete las paredes laterales con los pasadores de goma (23) al armazón. Las paredes finales se fijan directamente al techo con los pasadores de goma cortos (24). Fije las paredes finales al suelo con los clavos de tierra cortos (18). La cuerda tensora se extiende desde cada esquina de la carpa y se sujeta al suelo con el gancho roscado (16).

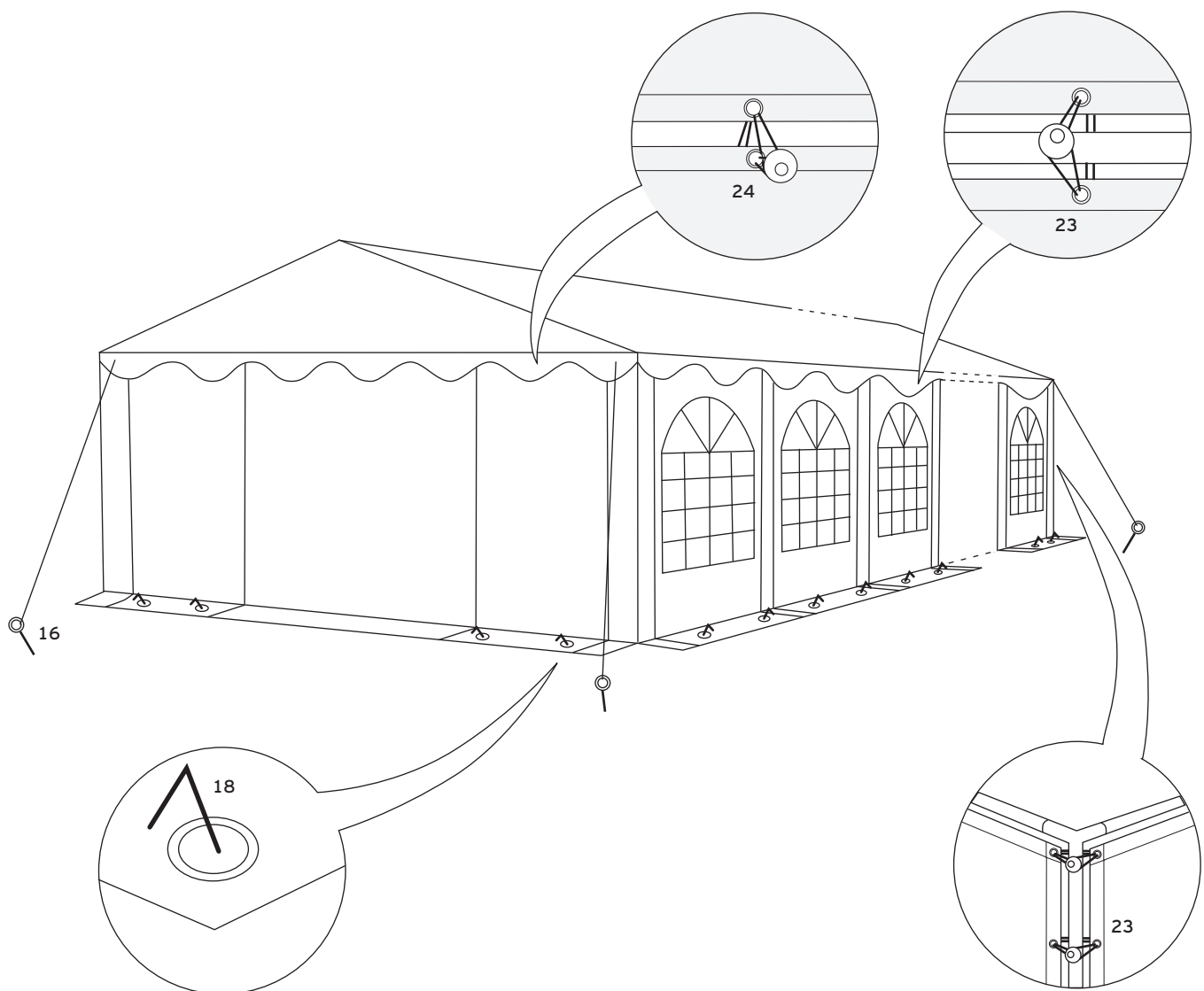

Limpeza y mantenimiento

El techo y las piezas laterales pueden lavarse con lejía jabonosa. Limpie el moho y las manchas de humedad con una solución suave de cloro. Siga las instrucciones del fabricante y pruebe la solución de cloro en una zona que no se vea para asegurarse de que no se produzcan decoloraciones.

¡Atención! No pliegue la carpa ni la embale si está húmeda, deje que antes se seque por completo.

Advertencias

1. Procure manejar la carpa con cuidado para evitar daños.
2. No ejerza demasiada fuerza sobre las barras, ya que podrían dañarse.
3. Las carpas han sido diseñadas como alojamiento temporal y deben desmontarse en caso de condiciones atmosféricas desfavorables.
4. Procure que siempre haya una distancia adecuada con tubos y conducciones de gas o electricidad para evitar que se dañen.
5. Si se utilizan calefactores adecuados (infórmese en un comercio especializado), se ha de mantener una distancia de al menos 1,2 m con el material de las lonas. No haga nunca fuegos al aire libre ni utilice calefactores con llamas libres, como estufas para terrazas, calentadores de gas, etc.
6. La persona que instale la carpa es responsable de realizar un anclaje adecuado de la misma para garantizar su seguridad.